

CRISTAL SS 30 / 36

body components

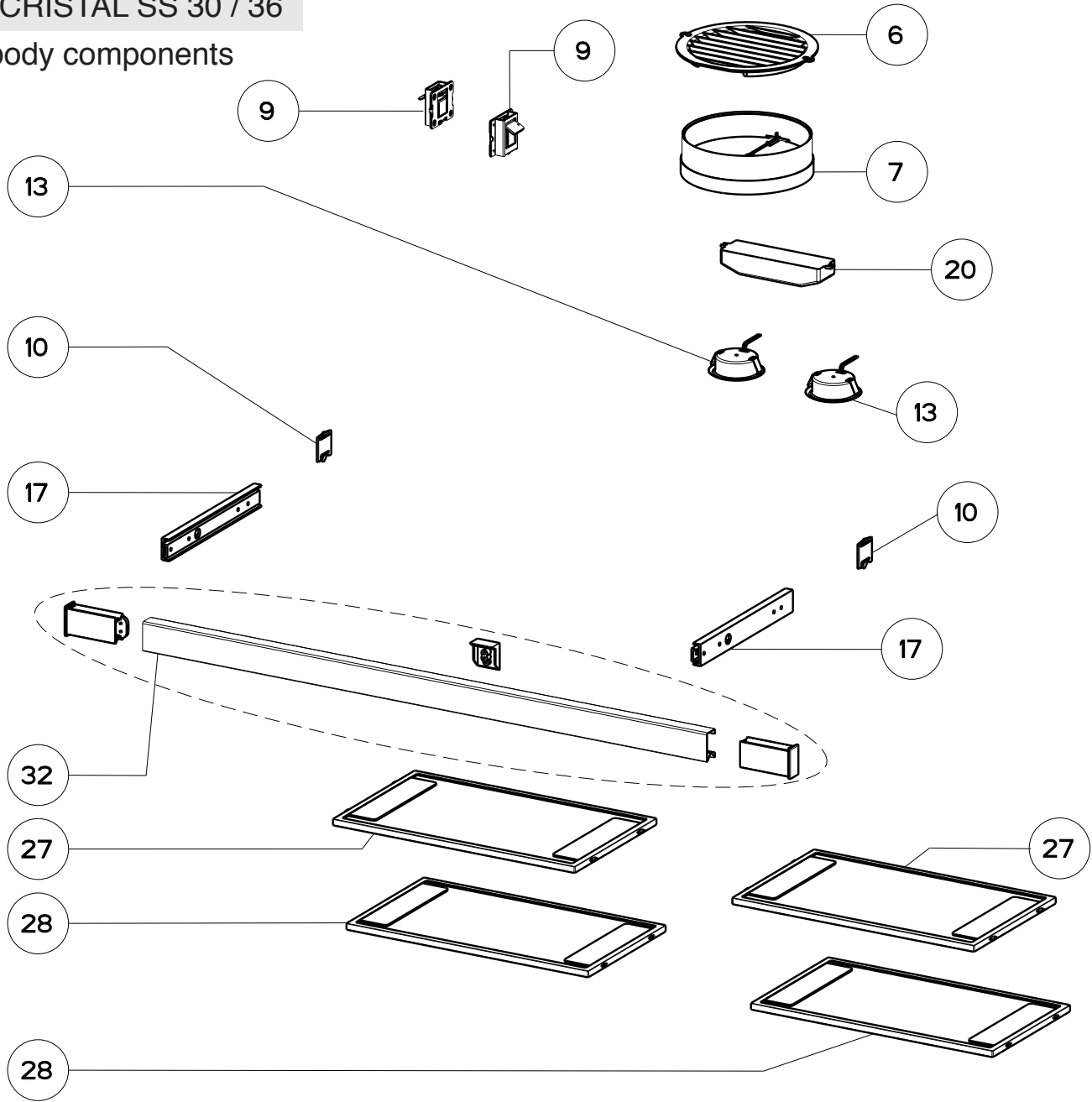

	Model Number	CRIS30SSH	CRIS36SSH	CRIS30SSH300	CRIS36SSH300	
Key	Description	30	36	30	36	Qty Req.
6	Vent Grate	133.0016.964	133.0016.964	133.0016.964	133.0016.964	1
7	Damper	133.0055.994	133.0055.994	133.0055.994	133.0055.994	1
9	Hinge Clips Kit (2 in kit)	133.0078.993	133.0078.993	133.0078.993	133.0078.993	1
10	Limit Switch Kit	133.0073.613	133.0073.613	133.0073.613	133.0073.613	1
13	Halogen Lamp Kit	133.0052.793	133.0052.793	133.0052.793	133.0052.793	2
13	Halogen Lamp (bulb only)	133.0000.001	133.0000.001	133.0000.001	133.0000.001	2
17	Slide Guide	133.0068.113	133.0068.113	133.0068.113	133.0068.113	1
20	Transformer	133.0174.154	133.0174.154	133.0174.154	133.0174.154	1
27	Front Grease Filters	133.0073.623	133.0073.620	133.0073.620	133.0073.623	2
28	Rear Grease Filters	133.0073.624	133.0073.621	133.0073.621	133.0073.624	2
32	Stainless Front Trim	133.0335.893	133.0335.895	133.0335.893	133.0335.895	1

CRISTAL SS 30 / 36

control components

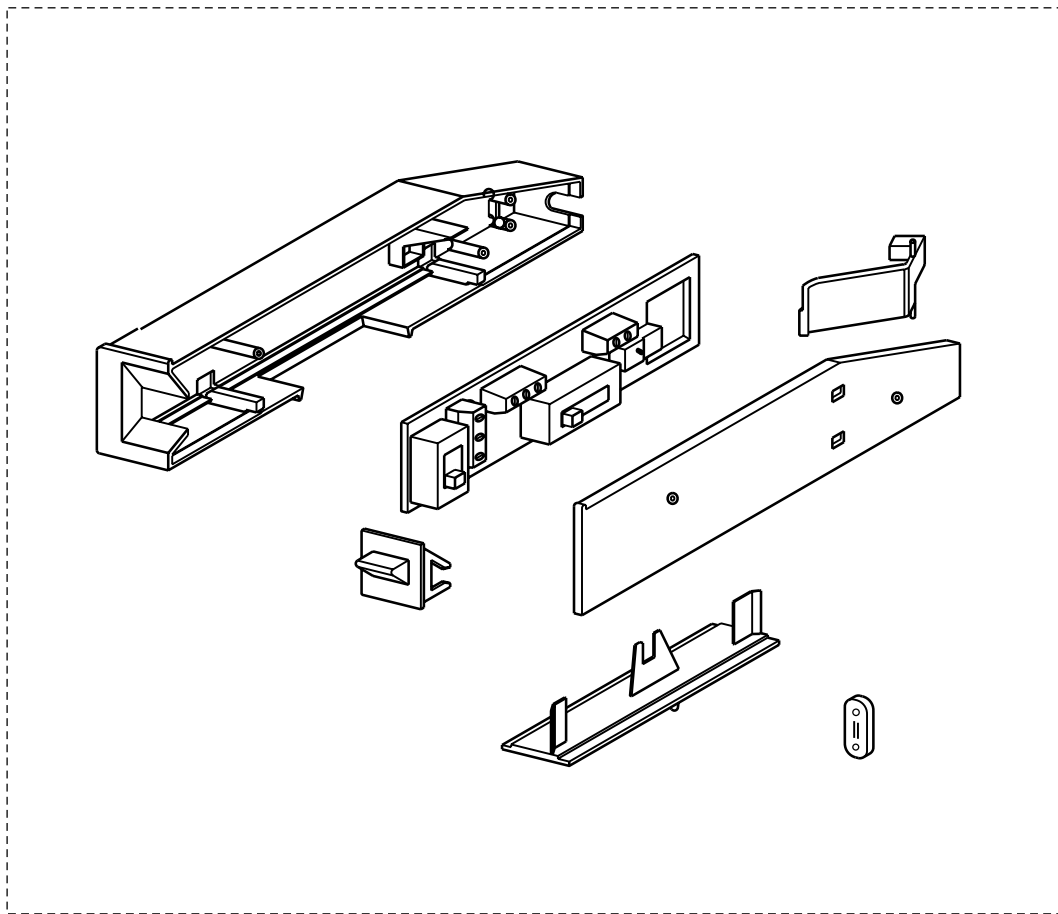

199

	Model Number	CRIS30SSH	CRIS36SSH	CRIS30SSH300	CRIS36SSH300	
Key	Description	30	36	30	36	Qty Req.
199	Control Board Kit	133.0336.159	133.0336.159	133.0336.159	133.0336.159	1

CRISTAL SS 30 / 36

motor components

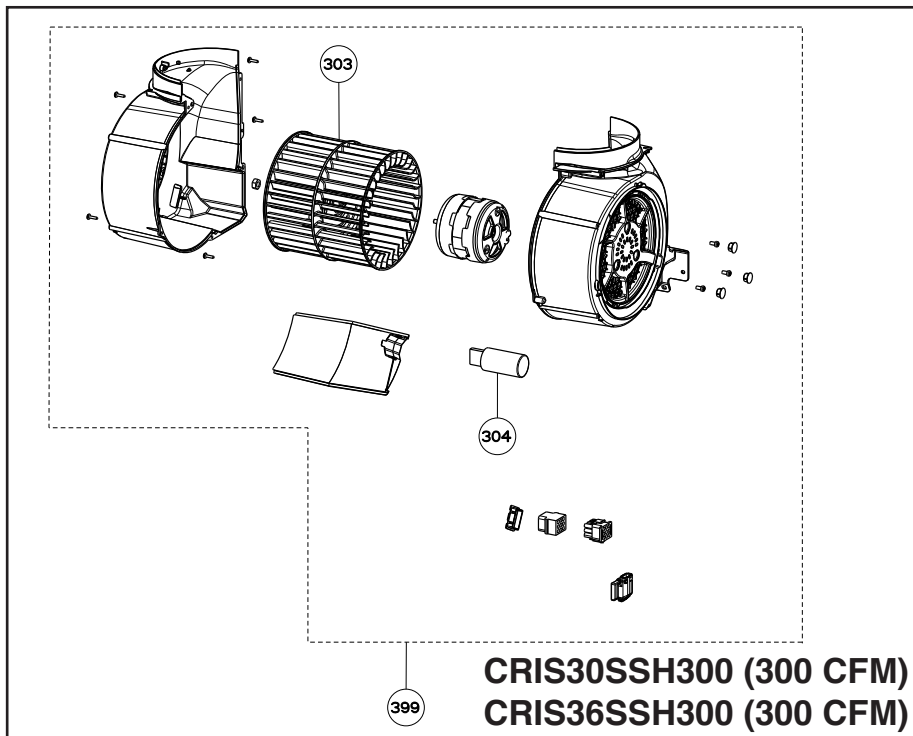
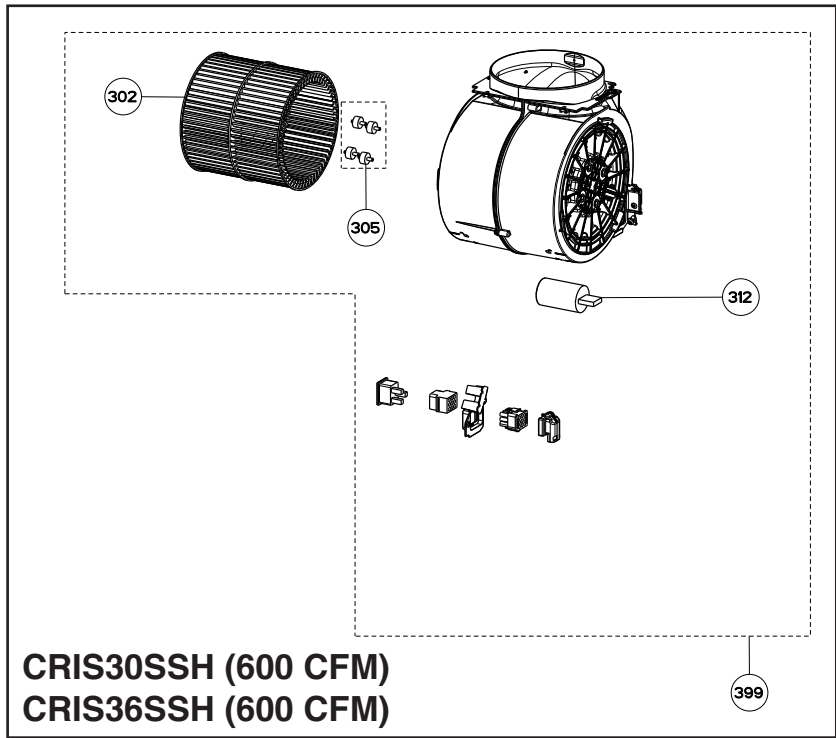

	Model Number	CRIS30SSH	CRIS36SSH	CRIS30SSH300	CRIS36SSH300	
Key	Description	30	36	30	36	Qty Req.
302	Impeller	133.0052.799	133.0052.799			1
305	Rubber Motor Mount	133.0051.604	133.0051.604			1
312	Capacitor (25MF 250V)	133.0060.648	133.0060.648			1
399	Motor Kit	133.0052.798	133.0052.798			1
303	Impeller			133.0178.632	133.0178.632	1
304	Capacitor (14MF 240V)			133.0071.827	133.0071.827	1
399	Motor Kit			133.0178.492	133.0178.492	1