



# **Trouble Shooting Guide**

**CMA Dishmachines  
12700 Knott Street  
Garden Grove, CA. 92841  
(800) 854-6417**



---

---

## Table of Contents

Machine Will Not Start.....	2
Wash Pump Runs – Timer Will Not Cycle.....	3
Machine Cycles, Normal Wash Pump Will Not Run.....	4
Machine Will Not Turn Off.....	5
Dishwasher Will Not Drain, Drain Bill Not Lifting.....	6
Drain Will Not Close, Drain Ball Will Not Fall.....	7
Chemical Pumps Will Not Run .....	8
Machine Will Not Fill With Water – Machine Runs .....	9
Machine Only Fills During The Wash Cycle .....	10
Machine Only Fills When Fill Switch is Used.....	11
Fill Valve Only Runs During the Wash Cycle.....	12
Machine Only Fills When Fill Switch is Used.....	13
Fill Water Will Not Shut Off... ..	14
Wash Tank Heater Is Not Getting Hot.....	15
Booster Heat Not Getting Hot (Final Rinse).....	16

**Parts and Service Manuals Are Available At:**  
**[www.cmadishmachines.com/products.html](http://www.cmadishmachines.com/products.html)**

---

---



## Machine Will Not Start

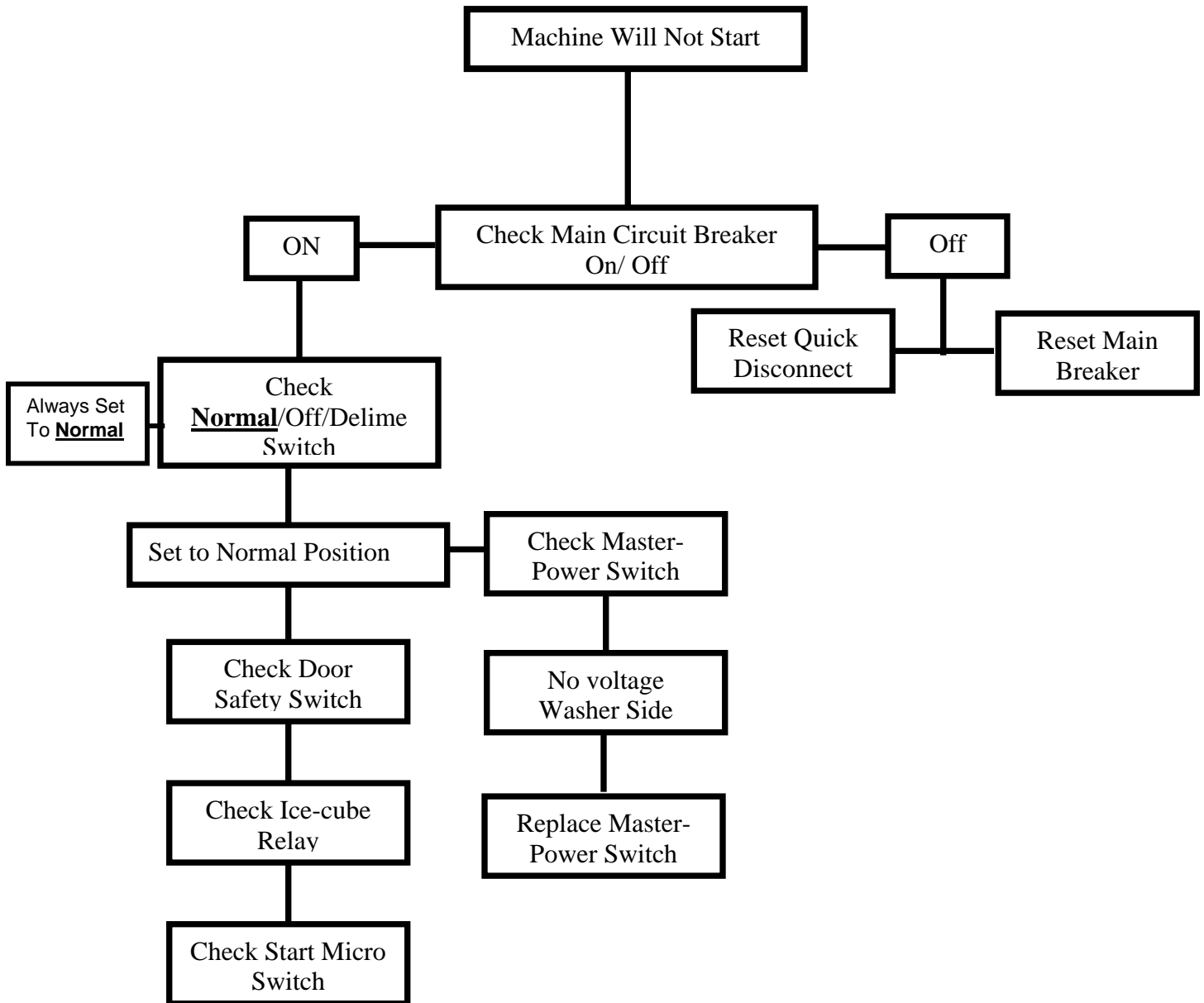



## Wash Pump Runs – Timer Will Not Cycle

Cycle of Operation:

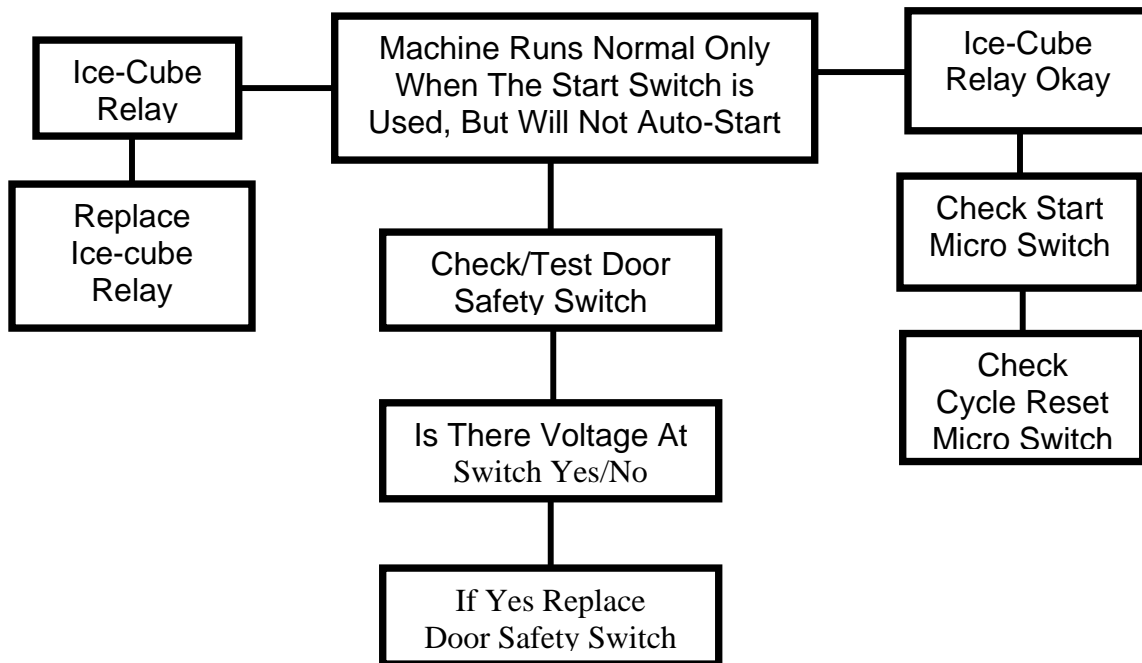



## Machine Cycles, Normal Wash Pump Will Not Run

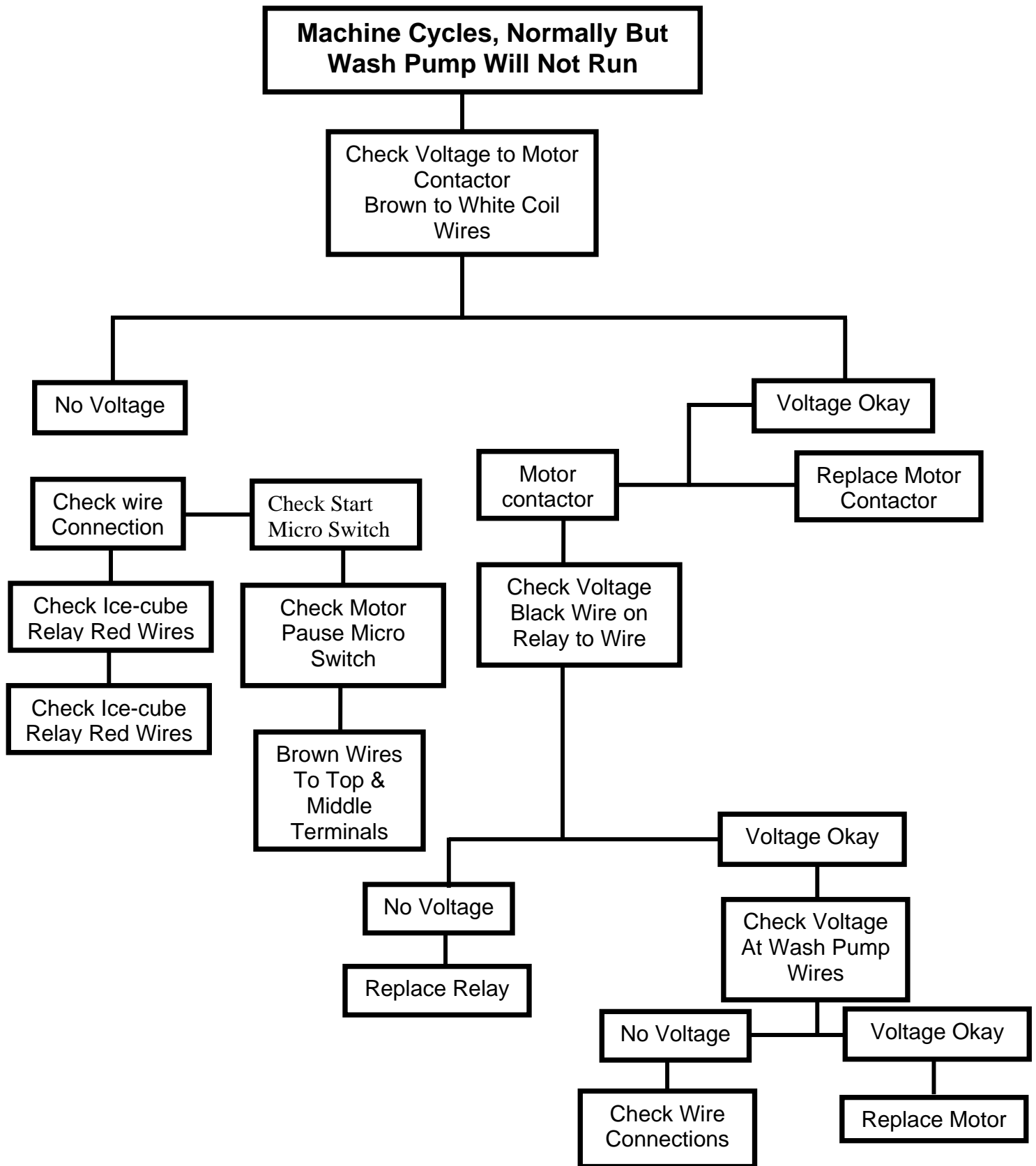



# Machine Will Not Turn Off

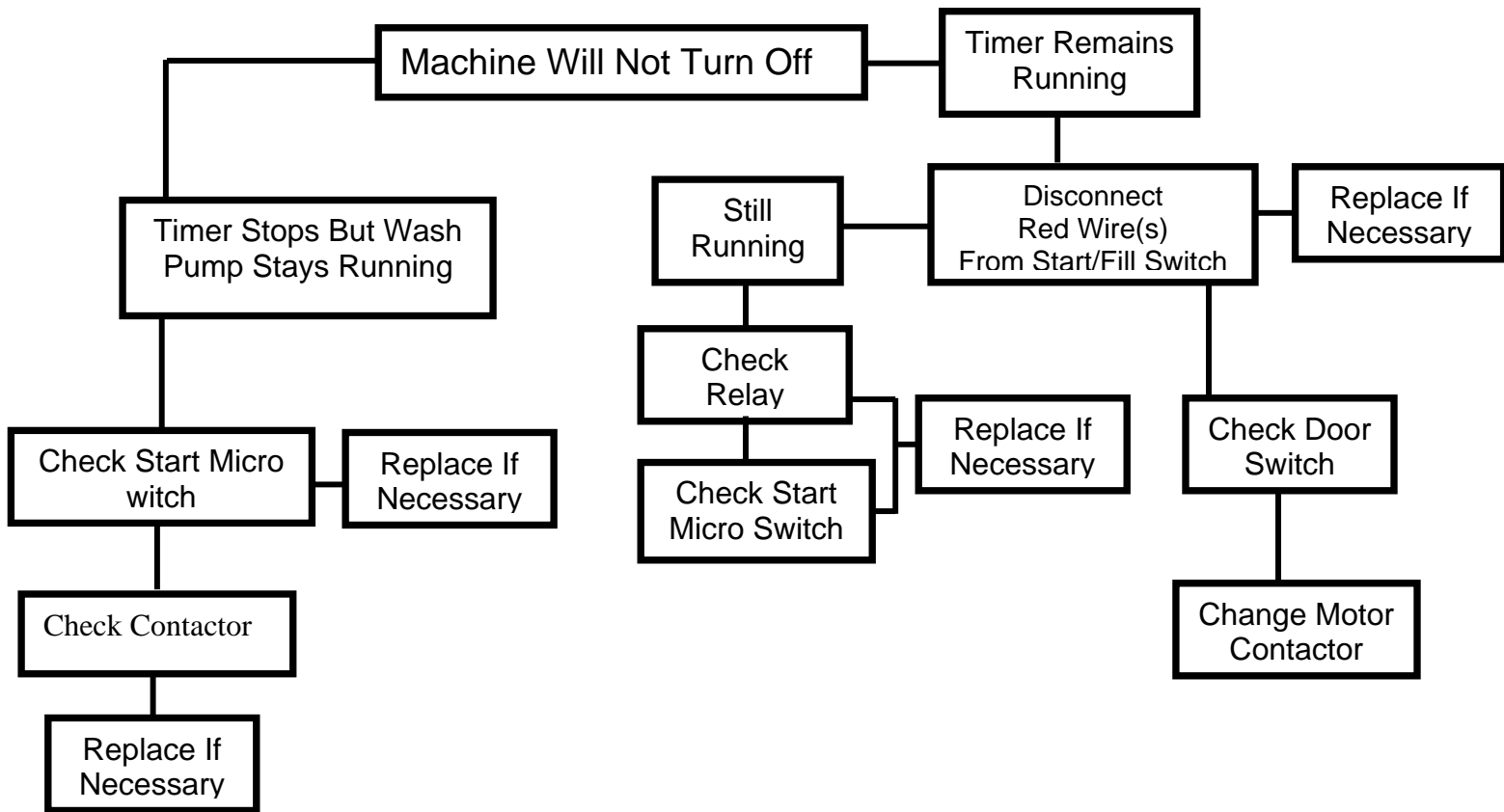



---

---

## Dishwasher Will Not Drain, Drain Ball Not Lifting.

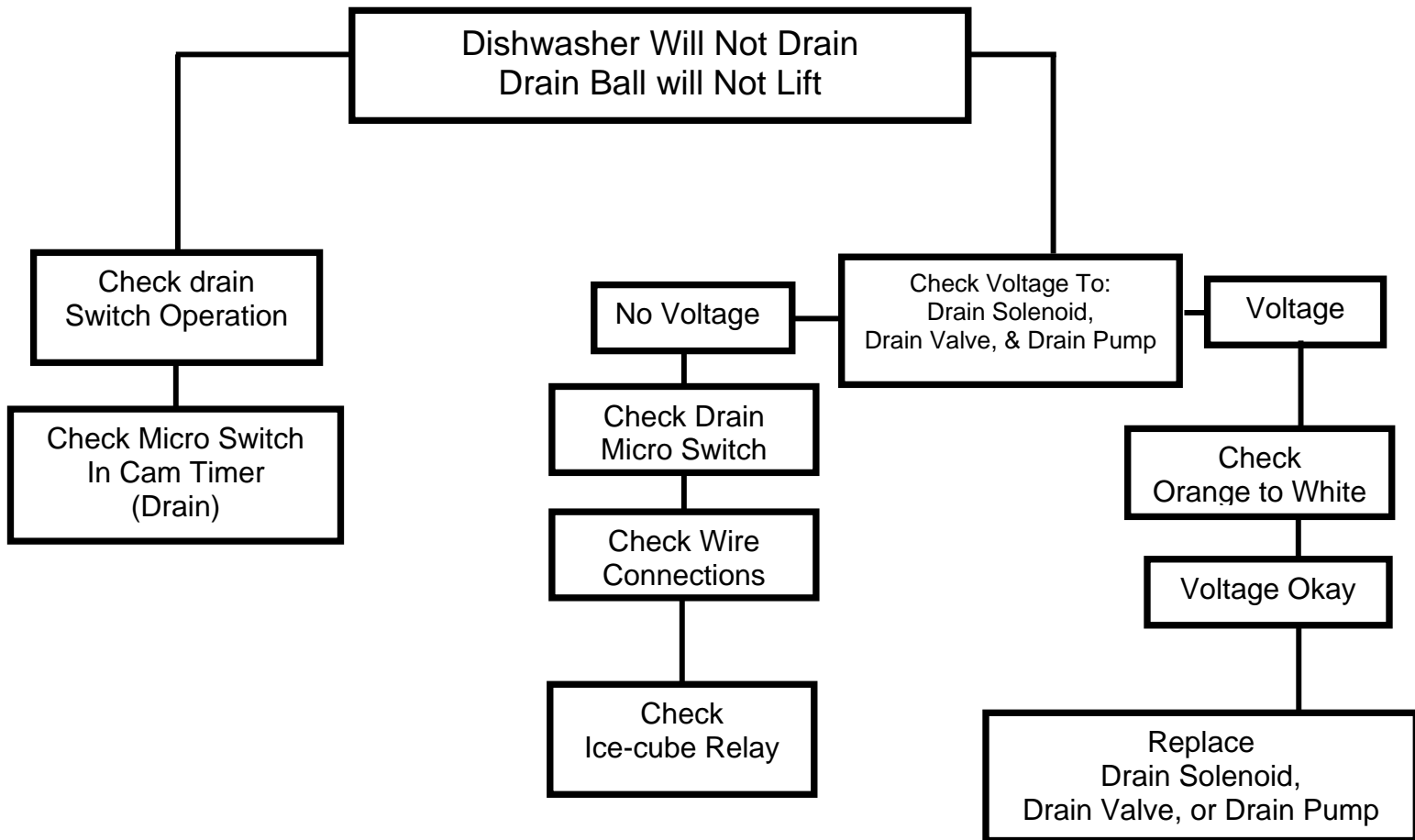



---

---

## Drain Will Not Close, Drain Ball Will Not Fall

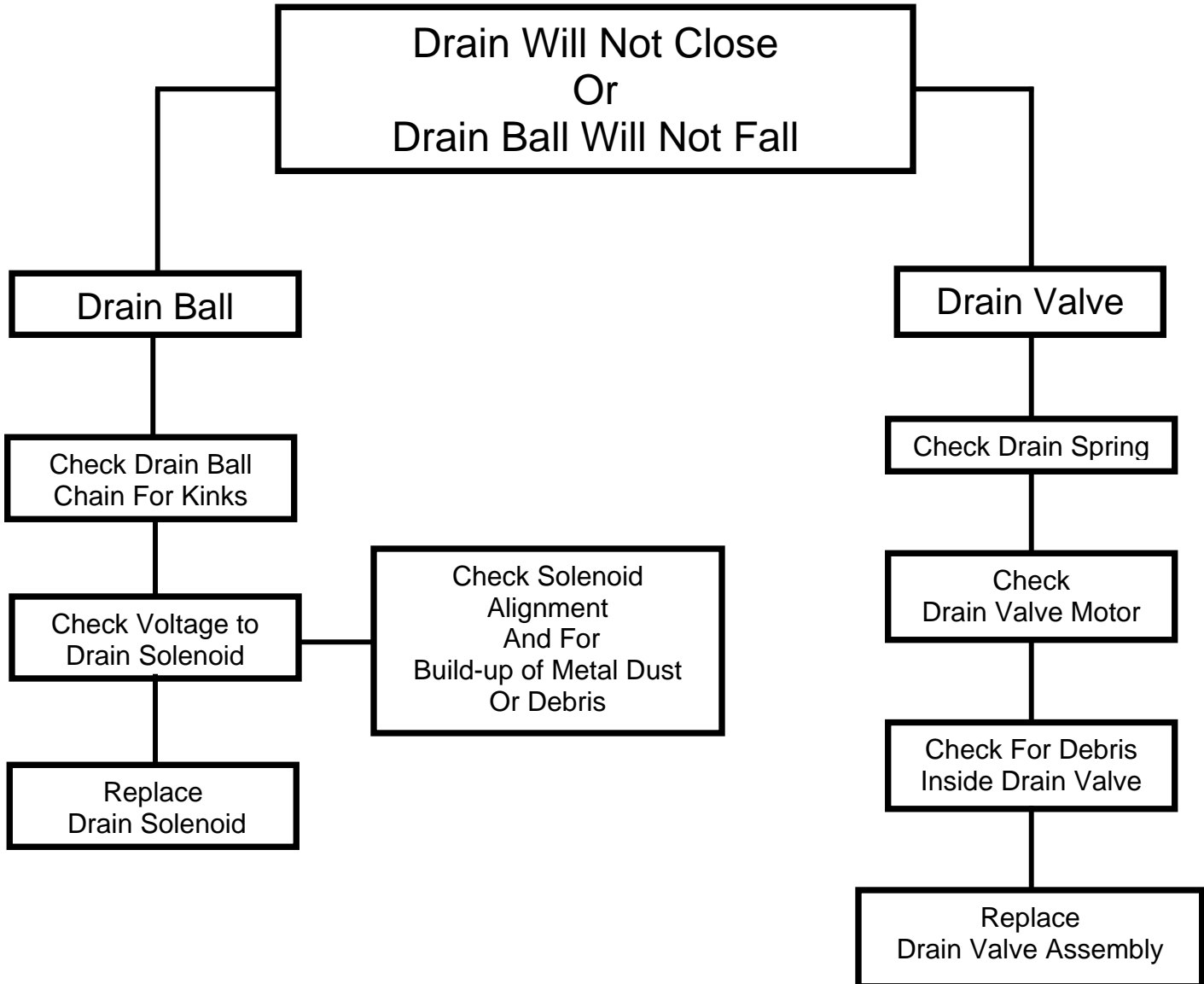





## Chemical Pumps Will Not Run

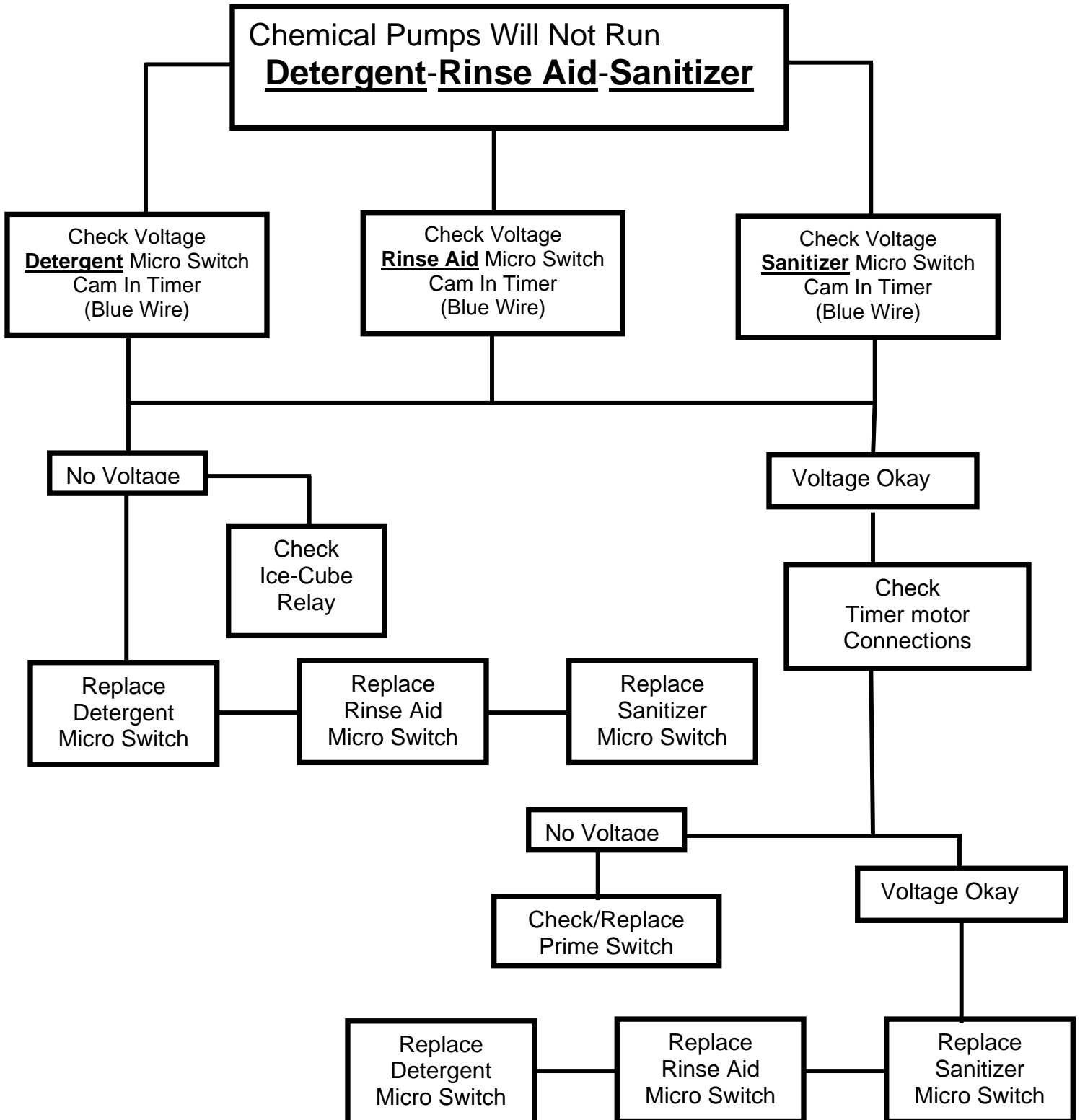



## Machine Will Not Fill With Water – Machine Runs

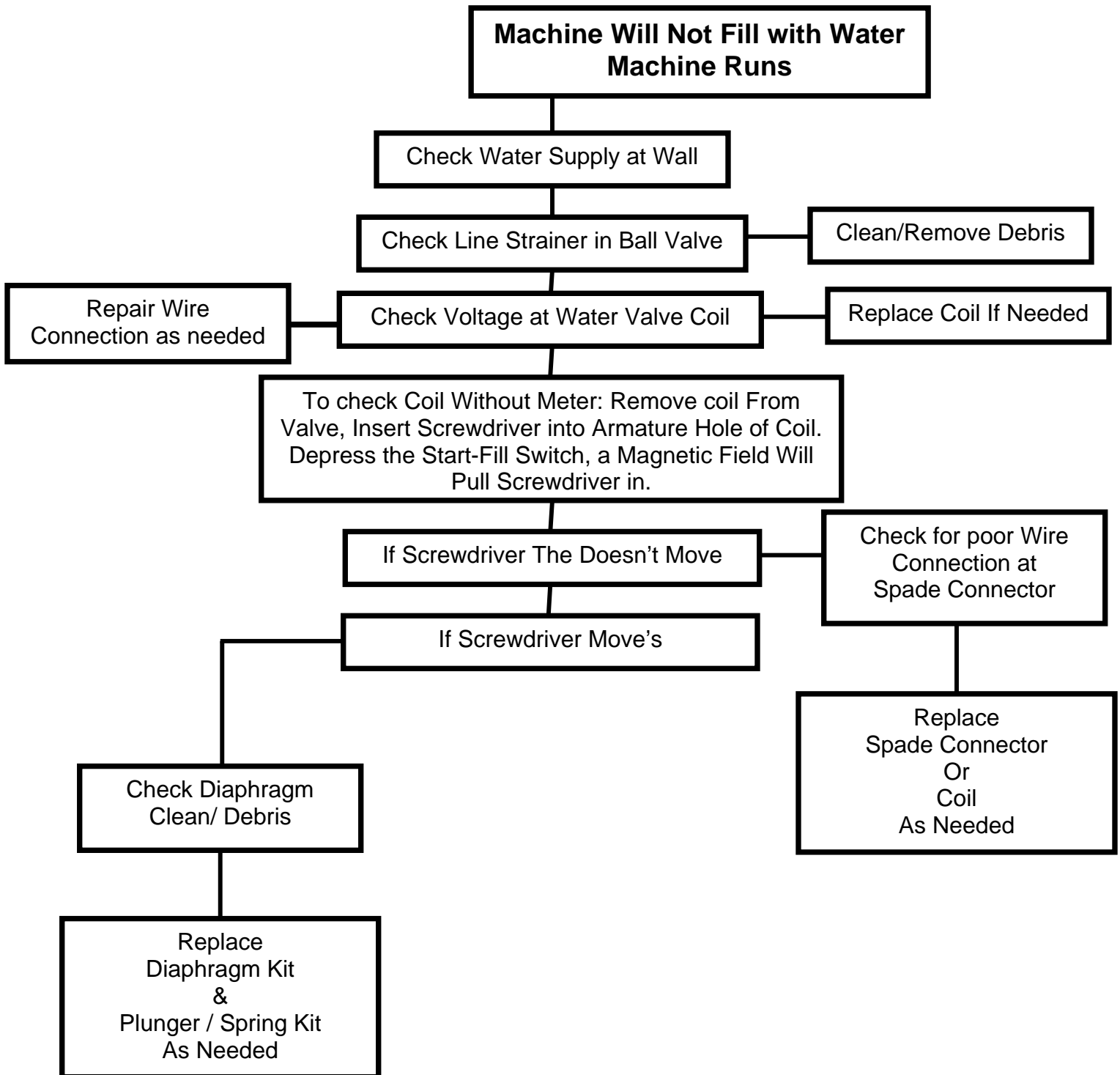



---

---

## Machine only Fills During The Wash Cycle

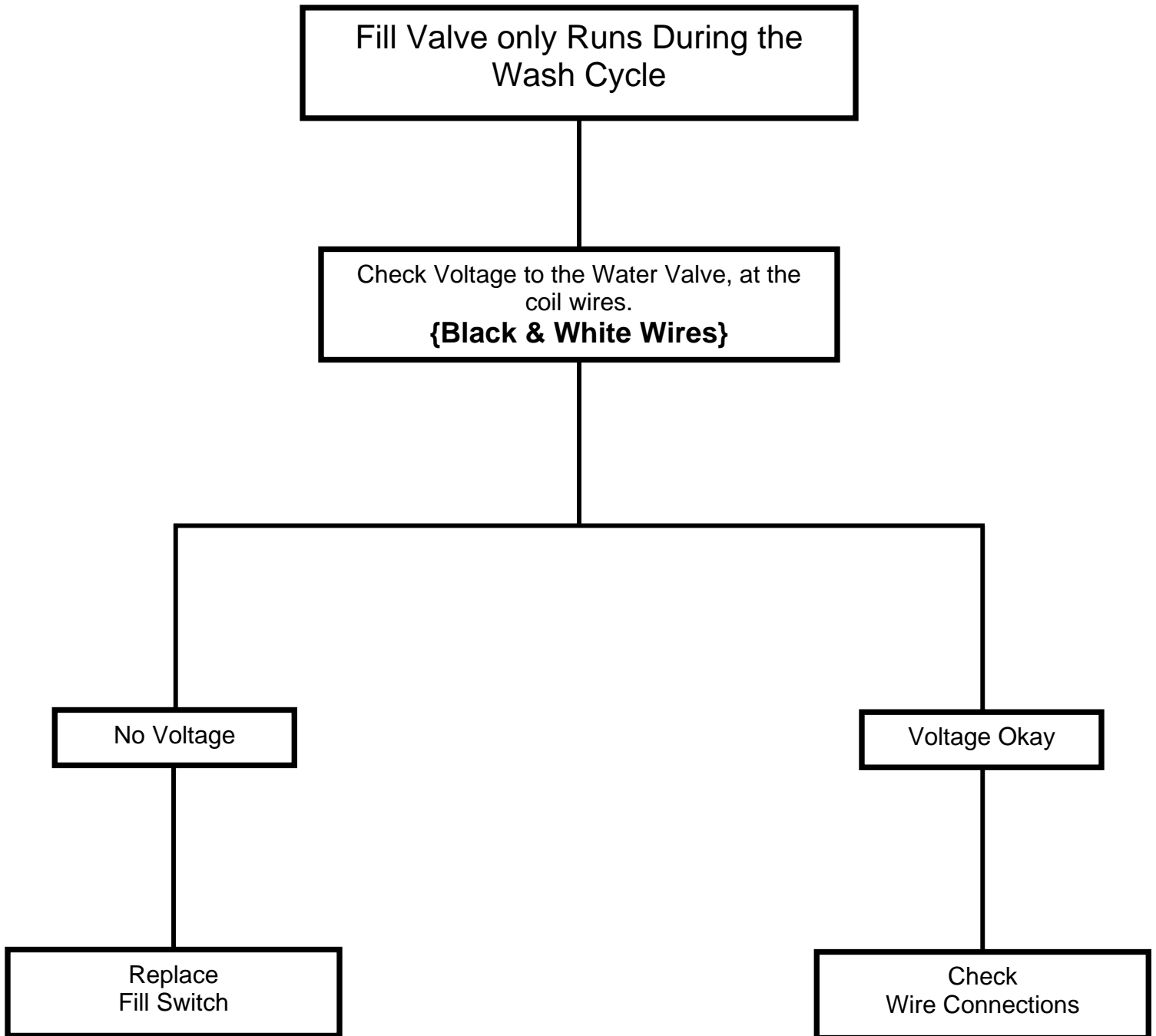



---

---

## Machine Only Fills When Fill Switch is Used

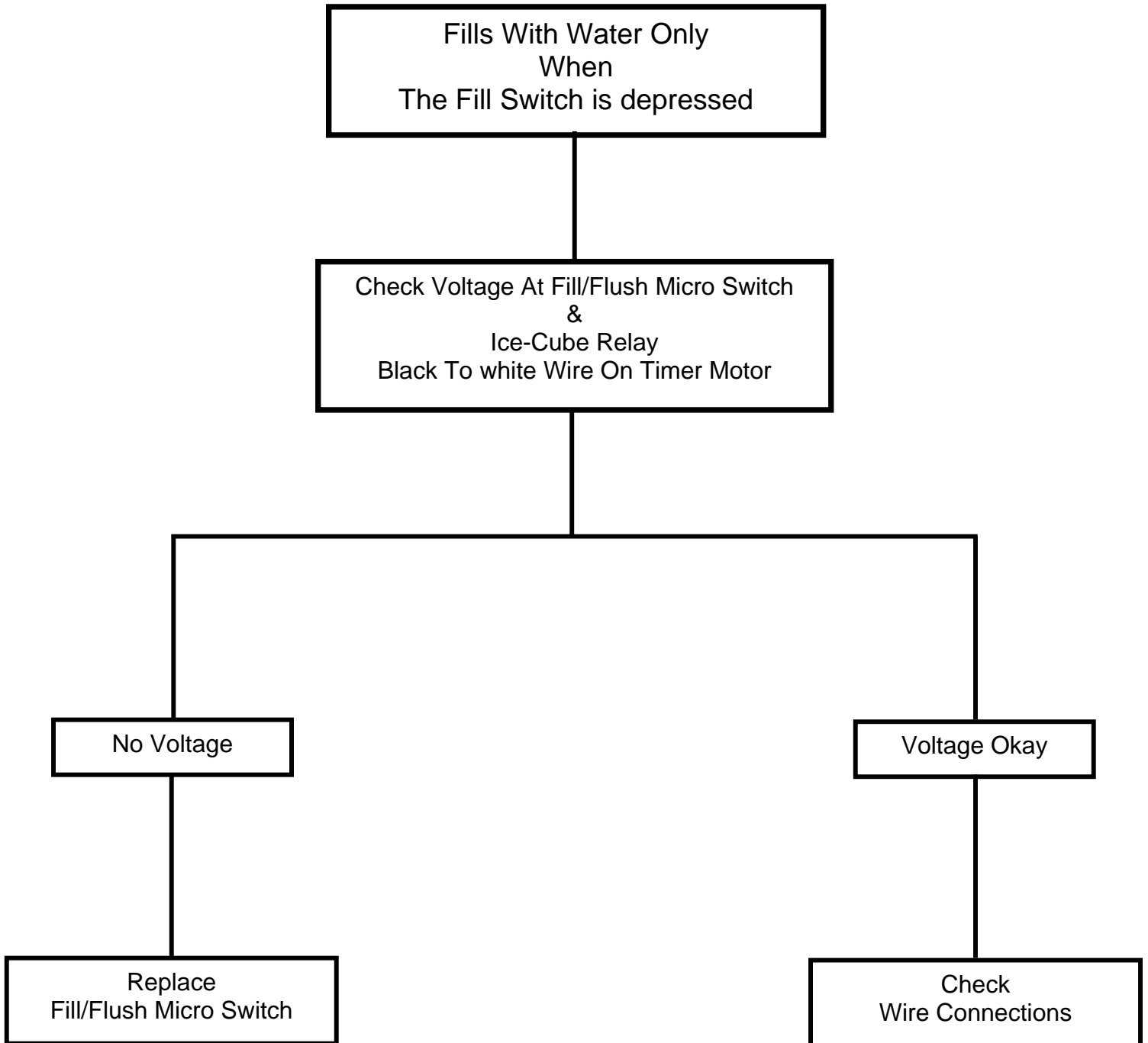



## Fill Valve only Runs During the Wash Cycle

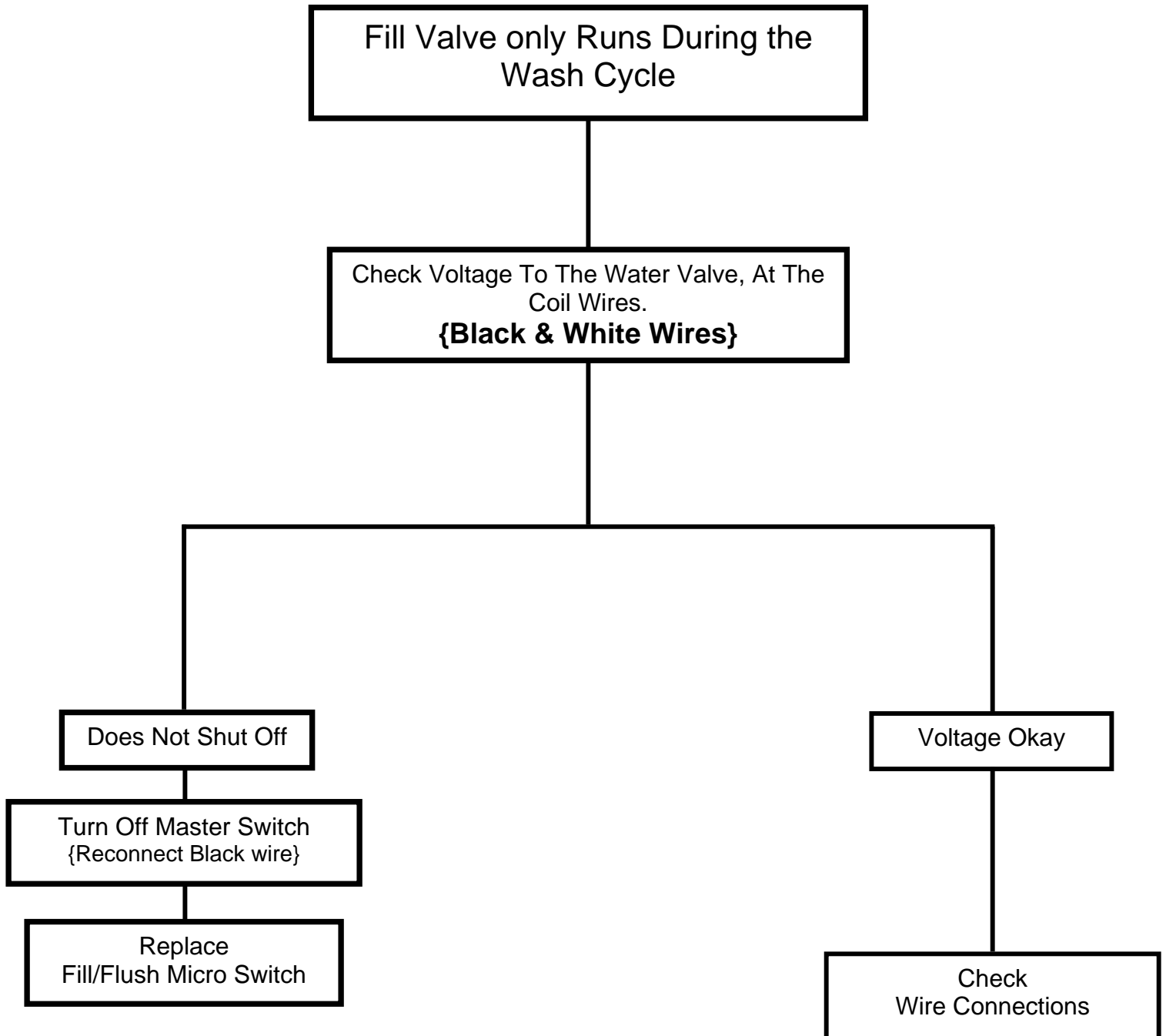



## Fill Water Will Not Shut Off

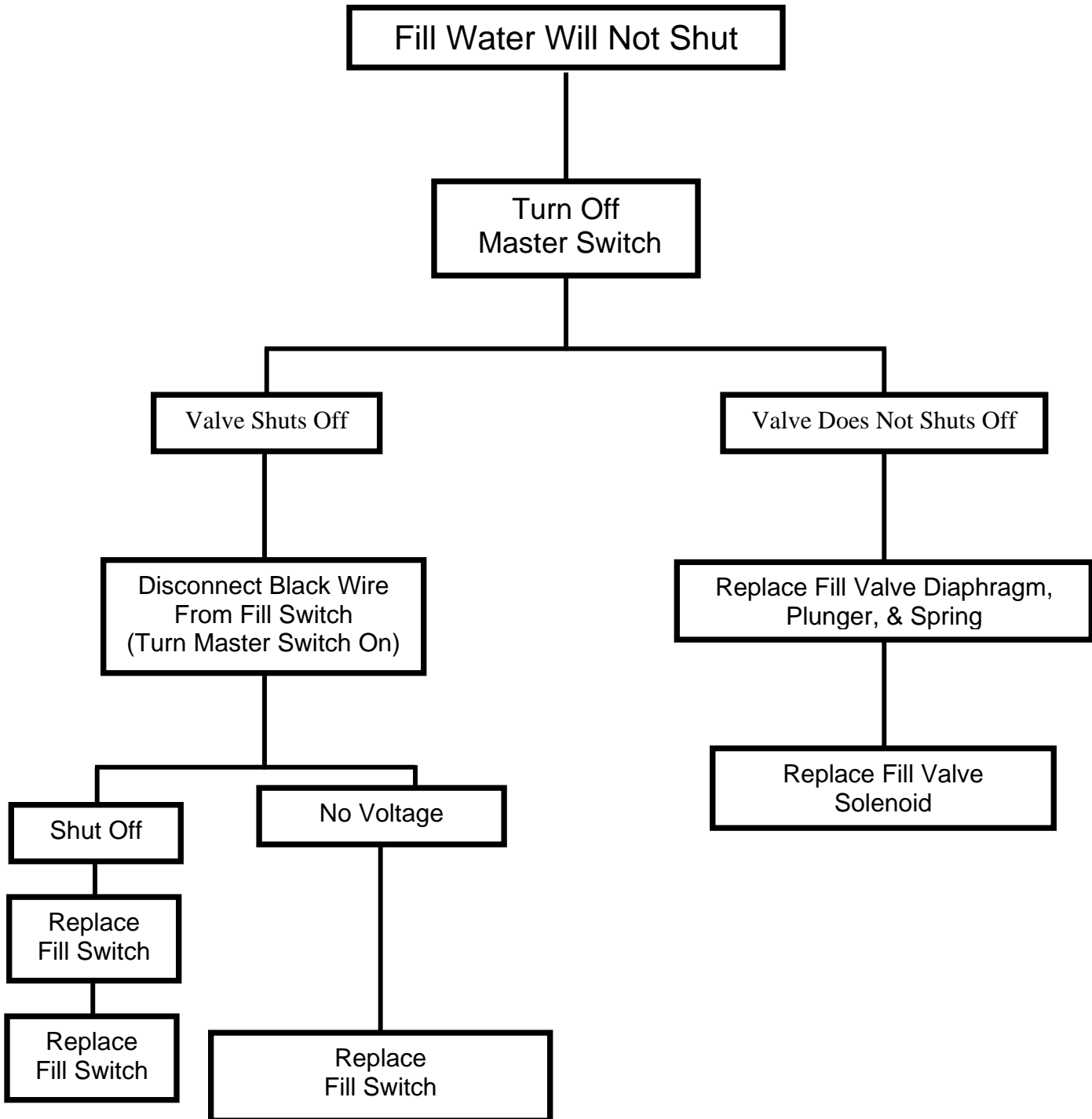



## Wash Tank Heater Is Not Getting Hot

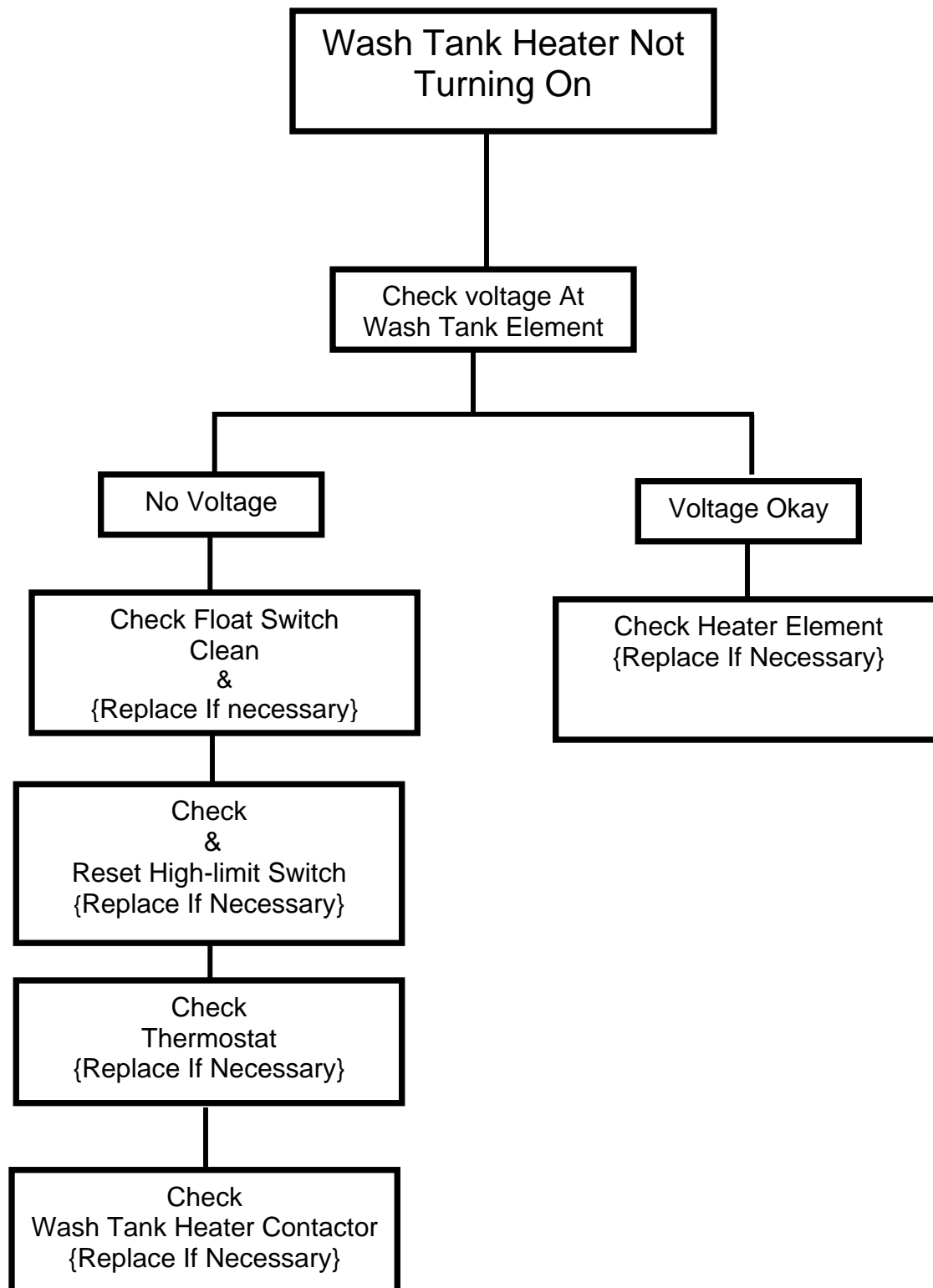



## Booster Heat Not Getting Hot (Final Rinse)

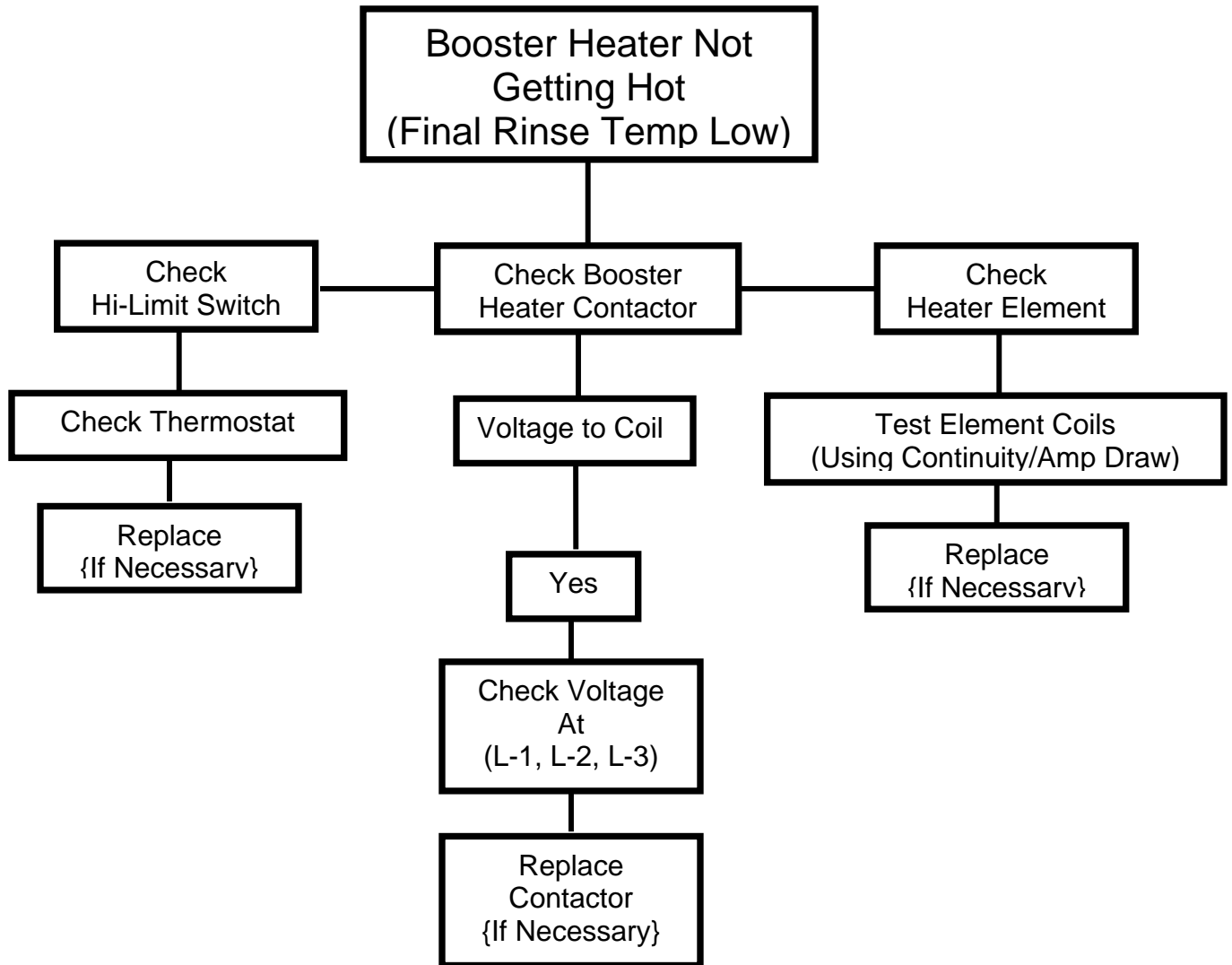





Peace of  
Mind

For More Information On How You Can Put The CMA Family  
To Work For You Call:  
(800) 854-6417

CMA Dishmachines  
12700 Knott Street  
Garden Grove, CA. 92841  
(800) 854-6417  
(714) 895-2141  
[www.cmadishmachines.com/products.html](http://www.cmadishmachines.com/products.html)