

COASTER
FINE FURNITURE

202411F (B1 & B2)

FULL SIZE BED

ASSEMBLY INSTRUCTIONS

COASTER FINE FURNITURE



www.coastercompany.com

PAGE 1 OF 4

REVISION 0 : 04 / 24 / 2012

ASSEMBLY TIPS

1. Remove hardware from box and sort by size.
2. Please check to see that all hardware and parts are present prior to start of assembly.
3. Please follow attached instruction in the same sequence as numbered to assure fast & easy assembly.







Warning !

1. Don't attempt to repair or modify parts that are broken or defective. Please contact the store immediately.
2. This product is for home use only and not intended for commercial establishment.

PARTS IDENTIFICATION

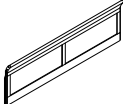
B1 (BOX 1)



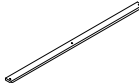
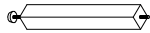
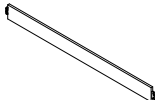
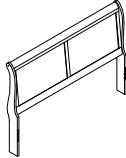
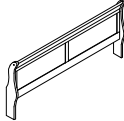

A		HEADBOARD PANEL	1PC
B		LEFT HEADBOARD LEG	1PC
C		RIGHT HEADBOARD LEG	1PC
D		FOOTBOARD PANEL	1PC
E		LEFT FOOTBOARD LEG	1PC
F		RIGHT FOOTBOARD LEG	1PC

B2 (BOX 2)

G		BED SLAT	4PCS
H		BED SLAT SUPPORT WITH LEVELER	4PCS
I		BED RAIL	2PCS
HB		202411F (B1) * FROM BOX 1 HEADBOARD COMPLETE	1PC
FB		202411F (B1) * FROM BOX 1 FOOTBOARD COMPLETE	1PC

HARDWARE IDENTIFICATION

Z - B1 (BOX 1)

1		BOLT	12PCS
2		LOCK WASHER	12PCS
3		FLAT WASHER	12PCS
4		WOOD PLUG	4PCS
5		ALLEN WRENCH	1PC

Z - B2 (BOX 2)

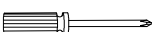
6		FLAT HEAD SCREW	8PCS
7		PHILIPS HEAD SCREW DRIVER	1PC

NOTE : MANUFACTURER DOES NOT PROVIDE ITEM 7

202411F (B1) - BOX1

STEP 1

Align and fasten headboard legs to headboard panel using bolt, lock washer and flat washer and tighten with Allen wrench. Insert the wood plugs into legs

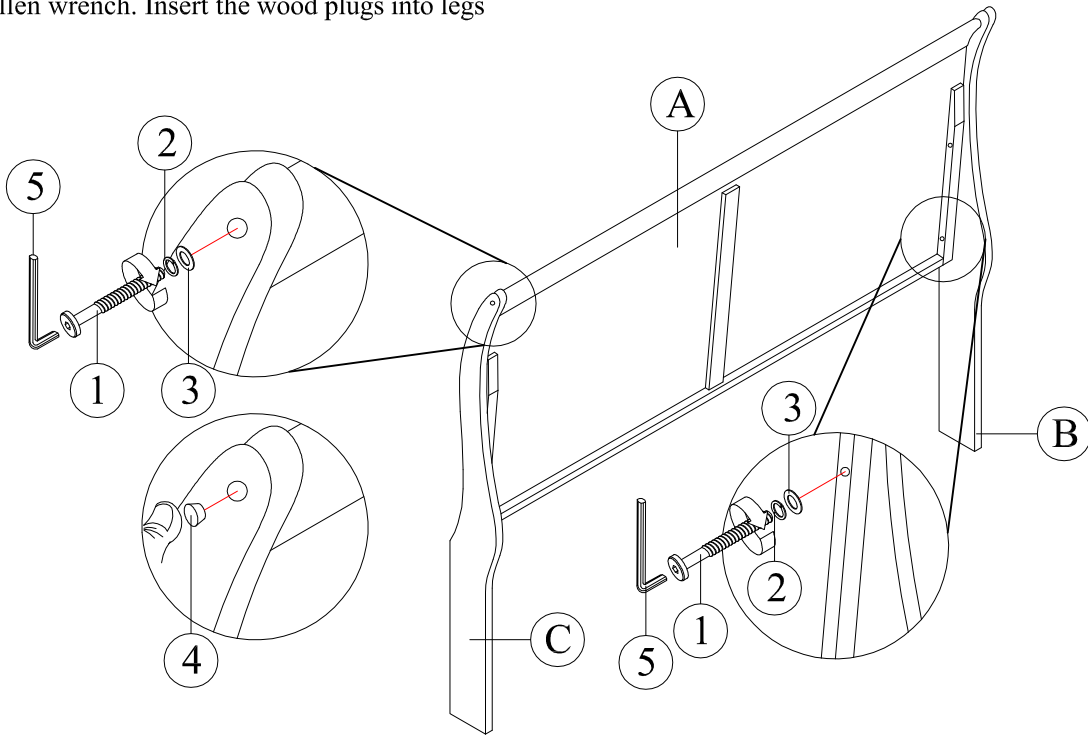

STEP 2

Align and fasten footboard legs to footboard panel using bolt, lock washer and flat washer and tighten with Allen wrench. Insert the wood plugs into legs

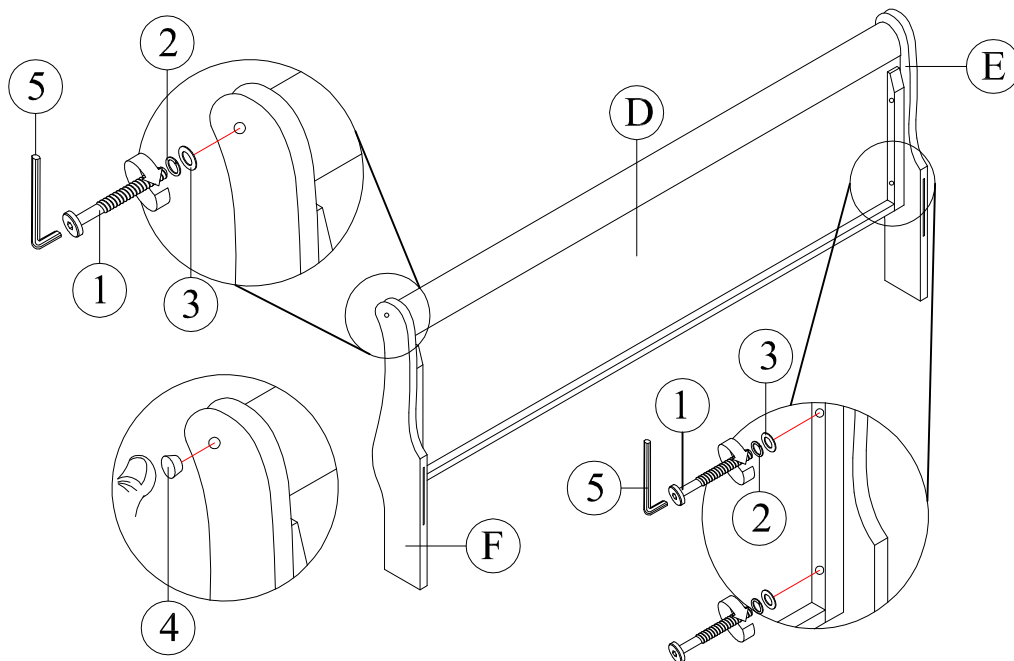

202411F (B1 & B2) - BOX1 & BOX2

STEP 3

Align and hook the bed rails to headboard and footboard

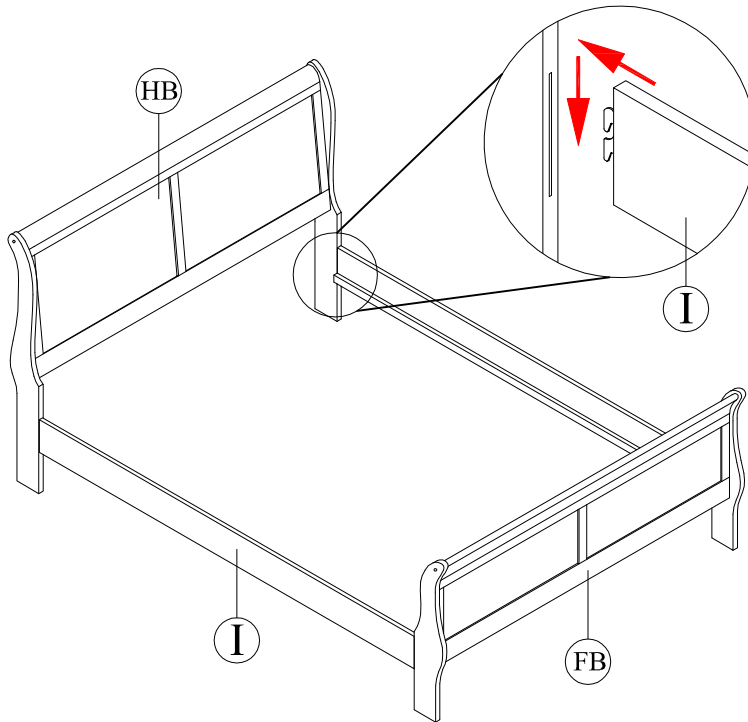

STEP 4

Align and screw in bed slat support to bed slat.

Align and fasten bed slat to bed rails using screws and tighten with screw driver (not provided).

