

COASTER[®]
FINE FURNITURE

100889N

COUNTER HEIGHT CHAIR

**ASSEMBLY INSTRUCTIONS
COASTER FINE FURNITURE**



WWW.COASTERCOMPANY.COM





ASSEMBLY TIPS :

1. Remove hardware from box and sort by size.
2. Please check to see that all hardware and parts are present prior to start of assembly.
3. Please follow attached instructions in the same sequence as numbered to ensure fast & easy assembly.







**Warning !**

1. Don't attempt to repair or modify parts that are broken or defective. Please contact the store immediately.
2. This product is for home use only and not intended for commercial establishments.

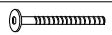
PARTS IDENTIFICATION :

NO	DESCRIPTION	FIGURE	Q'TY
1	CHAIR BACK		2 PCS
2	CUSHION SEAT WITH FRAME		2 PCS
3L	LEFT SIDE STRETCHER		2 PCS
3R	RIGHT SIDE STRETCHER		2 PCS
4L	LEFT FRONT LEG		2 PCS
4R	RIGHT FRONT LEG		2 PCS
5	FRONT STRETCHER		2 PCS

HARDWARE IDENTIFICATION :

NO	DESCRIPTION	FIGURE	Q'TY
A	LONG BOLT	 1/4"x75mm	8 PCS
B	MEDIUM BOLT	 1/4"x60mm	8 PCS
C	SHORT BOLT	 1/4"x38mm	2 PCS
D	LOCK WASHER		18 PCS
E	FLAT WASHER	 5/16"x19mm	18 PCS
F	SCREW	 ∅4x40mm	12 PCS
G	ALLEN WRENCH	 M4x59mm	1 PC

NOTE : QUANTITIES SHOWN ARE FOR TWO CHAIRS**STEP 1**

- 1.1 Align & hand tighten cushion seat with frame to chair back bottom rail using short bolt, lock washer & flat washer.
- 1.2 Align & hand tighten cushion seat with frame to chair back leg using long bolt, lock washer & flat washer.
- 1.3 Tighten all bolts with Allen wrench.
- 1.4 Insert left and right side stretchers to chair back legs.

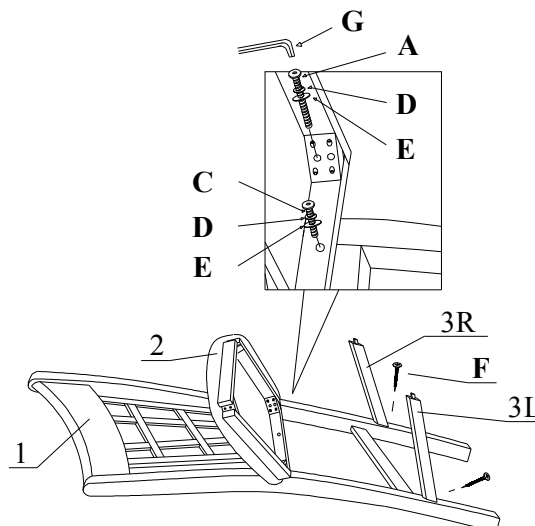

STEP 2

- 2.1 Insert front, left & right side stretchers to left and right front legs.
- 2.2 Then align & fasten left and right front legs to cushion seat with frame using medium bolt, lock washer & flat washer.
Tighten with Allen wrench.
- 2.3 Fasten front, left & right side stretchers to back, left & right front legs using screw.
- Tighten with screw driver (not included).

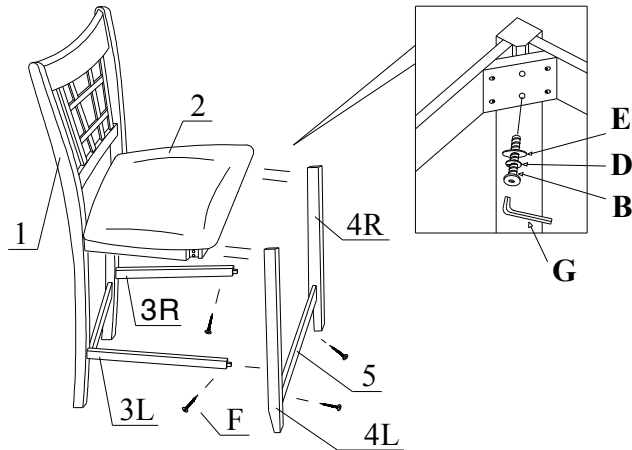
**STEP 3****Complete**