

# JUST-TECH

## LOW TEMP DISHWASHERS

### X-33



# Manual

**C**ongratulations on the purchase of your new Jet-Tech X-33 dishwasher.

Jet-Tech dishwashers have been used dependably for many years. This manual has been written to help YOU, the operator, perform your job more efficiently, because your job is one of the “most important” in the restaurant. WHY? One reason is that your product, the dishes and glasses, are the first thing that the customer sees when he sits down. Clean, sparkling dishes leave a favourable impression on the customer when he observes the table setting. Customers mean profit and profit means jobs yes, your job, the cooks, the waiters, and the managers you are all part of a team! The Jet-Tech dishwasher is a tool which you can use to make your job easier more efficient, and will help you deliver cleaner dishes.

Should you or the individual installing this unit have any questions or comments, please do not hesitate to contact our Customer Service Department (888-275-4538 x: 611).

Note: Our Technical Support Team is available 24/7.

Thank you for your support.

MVP GROUP CORP.  
TEL: (514) 737-9701  
FAX: (514) 342-3854  
TOLL FREE: (888) 275-4538  
TOLL FREE FAX: (877) 453-8832  
mvpgroupcorp.com  
service@mvpgroupcorp.com

- 2 Introduction
- 3 Index
- 4 Warranty
- 5 Specifications
- 6 To start
- 7 Installation, Electrical
- 8 Plumbing
- 9 Chemicals
- 10 Operation, Maintenance
- 11 Trouble shooting
- 11 Contact Information
- 12 Electrical diagram
- 13 Parts view 1
- 14 Parts View 2
- 15 Parts List

## MANUFACTURERS LIMITED WARRANTY

Jet Tech Systems Corporation (Jet Tech) hereby warrants all new warewashers bearing the name “JET TECH” and installed within the continental United States of America or Canada to be free from defects in material and workmanship, under normal and regular usage and operation, for a period of one (1) year following the date of original installation, (**unless specified otherwise**) but in no event can exceed eighteen (18) months from the date of shipment from the factory.

If a defect in material(s) or workmanship is detected; or found to exist within the stated period above, Jet Tech, at its sole discretion, shall either repair or replace any original equipment manufacturers part which has proven to fail within the machine; providing that the equipment has not been altered or tampered with in any manner, has been installed correctly as per the owners manual, and maintained and operated in complete accordance with this manual.

The labor cost to repair or replace any part proven to be defective, as per above clause(s), shall be covered by Jet Tech Systems, within the continental United States of America or Canada; provided that: prior authorization for this labor was approved by Jet-Tech Systems, the service work was performed by an authorized Jet Tech service agency; and that this agency installed an original and genuine Jet Tech part in the machine. Any repair work performed by a non-authorized service depot remains the sole responsibility of the user, and Jet Tech Systems will not be held responsible. **The installation of any generic part will not be valid; and therefore voids this warranty.** All authorized labor coverage shall be limited to regular hourly rates only. Any supplemental hourly rates or charges, such as weekends or emergency premiums remain the responsibility of the user.

Jet Tech Systems Corp. (Jet Tech) hereby states that: warranty travel time shall be limited to, and without exception, a round-trip total of two (2) hours OR mileage up to a maximum of one hundred (100) miles round-trip. Any charges exceeding those stated herein must have prior authorization by the factory.

**Exceptions to above warranty are:** (A) Damages resulting from shipping, handling or abuse. (B) Incorrect installation and/or connections. (C) Adjustments or calibration of any parts. (D) Faults due to lack of regular maintenance or cleaning of any internal part(s). (E) Replacement of any wearable items such as: glasswasher curtains, or peristaltic squeeze tubing or gaskets. (F) Excessive lime, mineral, alkali or hard water conditions (In excess of 6 grain) and (G) Poor results due to: use of an incorrect type of detergent (for non-commercial type applications), and excessive or inadequate water temperature(s) or pressure conditions or incorrect use. (H) Labour and mileage coverage does not apply upon condition of sale.

JET TECH SYSTEMS CORPORATION STATES THAT THERE ARE NO OTHER WARRANTIES, EXPRESSED OR IMPLIED, THAT ARE NOT SET FORTH HEREIN, JET TECH SYSTEMS CORPORATION SHALL ASSUME NO OTHER RESPONSIBILITY, EITHER DIRECT OR NON-DIRECT, OR BE LIABLE FOR ANY OTHER OR ADDITIONAL LOSS OR DAMAGE WHETHER BEING DIRECT OR CONSEQUENTIAL, AS A RESULT OF ITS EQUIPMENT.

### **Warranty:**

*One year parts & labor (Continental USA and Canada).*

*The manufacturer reserves the rights to alter design and specifications without notice.*

# Model X-33

## Low Temp Undercounter Dishwasher

X-33 cleans your dishes and glasswares.

This model is excellent for small restaurants, fast food operations, institutions, nursing homes, etc.

### HIGHLIGHT FEATURES

Fully automatic washing and rinsing operation with integrated chemical injection system.  
 Wash tank heater to ensure and maintain proper Temperature.  
 Sanitary Labyrinth door eliminates any gasket.  
 Deep drawn one piece unified inner chamber.  
 Rinse Additive pump for sparkling results.  
 Detergent pump for consistent results.  
 Sanitizer pump for proper sanitation.

### STANDARD FEATURES

Double-Wall insulation on top and side panels.  
 Stainless steel wash and rinse arms.  
 Body, external housing and all chassis components in brushed stainless steel AISI 304.  
 Inner wash tank in AISI 316 S/S.  
 .75 HP drip-proof pump motor.  
 Stainless steel wash pump impeller.  
 Door safety switch.  
 Adjustable peristaltic pumps for detergent, rinse and Sanitizer.  
 Door opening height 15 inches.  
 Built-in or Free standing installation.  
 Reliable mechanical-type cam timer.  
 Automatic drain pump.  
 Detergent/chemical connections.



### TECHNICAL FEATURES

Racks per hour: 37  
 Water consumption per cycle (Gal.): 1.02  
 Wash Motor: 0.75 HP  
 Temperature: 140 F°  
 Wash time: 45 seconds  
 Dwell time: 12 seconds  
 Rinse time: 28 seconds  
 Total cycle time: 85 seconds

### UTILITIES

Electrical: Machine connection / Machine Load Amps - 115 Volts/60, 13 Amps
Water: 3/4" male hose X 6 ft. (supplied) / 140 F Hot Water Connection
Incoming Flow Pressure: 25 PSI (Pressure reducing valve optional)
Drain: 1" I.D. hose X 5.5 ft. (supplied)

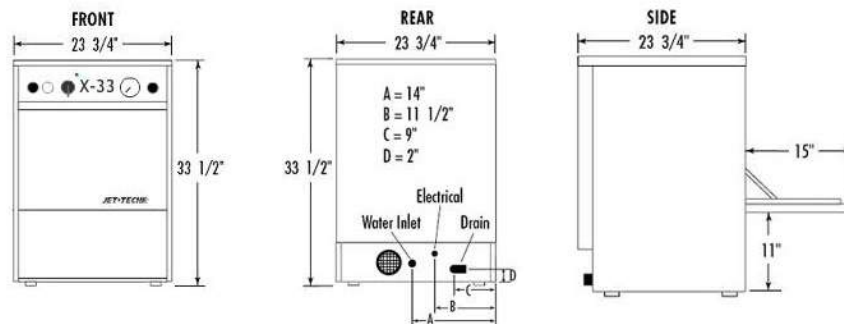

MVP GROUP CORP.  
 TEL: (514) 7379701  
 FAX: (514) 3423854  
 TOLL FREE: (888) 2754538  
 TOLL FREE FAX: (877) 4538832  
 mvpgroupcorp.com sales@mvpgroupcorp.com

# Getting Started

Immediately upon receipt of your new X-33 dishwasher, remove the cardboard box and inspect the dishwasher for any obvious signs of damage. If you find any traces of damage, contact the transport company that delivered the dishwasher to your location. A damage claim must be made immediately with the carrier.

Included with your X-33 dishwasher;

- (1) 20 x 20 open rack
- (1) 20 x 20 peg rack for dishes
- (1) fill hose
- (1) drain hose
- (4) adjusting feet
- (1) operator manual



## Installation

This dishwasher must be installed on a level, rigid, non-flammable surface (i.e.:ceramic tiles, concrete, sheet metal, etc). Ensure that the machine is level by installing the feet (shipped in the wash tank of the machine) and adjusting them. Be sure to provide adequate space for water, drain and electrical connections.

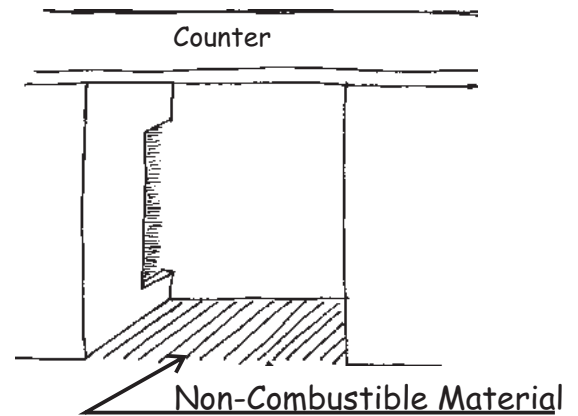

## Electrical

The dishwasher must be connected with 120 volts 60Hz line.  
The cord and plug on this unit must not be modified or tempered.  
Unit must be well grounded. Breaker rating should be 15 amps.





# Plumbing

## WATER INLET

A 3/4" NPT coupling is required with a maximum of 30 p.s.i. dynamic pressure, and a minimum of 20 p.s.i. . A water pressure regulator is required. The water pressure should be 25 p.s.i. .

Incoming water temperature must be 140° F (60° C). An easily accessible shut-off valve is recommended.

Flexible hoses must be used to make installation, servicing and maintenance easier.

Make sure that the water is free from calcium and hard water deposits. Water with a mineral content of 6 grains or higher must have an on-line water filtering system or another type of water softening system. Build-up of calcium and lime deposits in the washer may occur and servicing will be required on a more frequent basis which will not be covered by warranty.

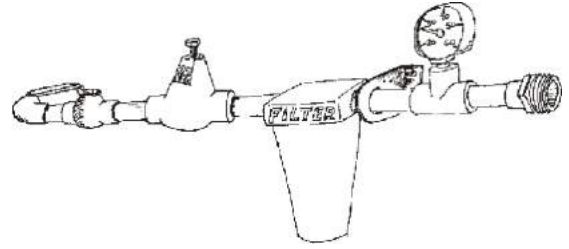

## DRAIN

The X-33 will pump the drain water manually or automatically. A 1" ID flexible drain hose (included) is recommended to facilitate maintenance and servicing of the machine. It is important not to reduce the size of this hose. Secure the drain hose well as the drain water pressure is approximately 10 p.s.i..

Rear of dishwasher

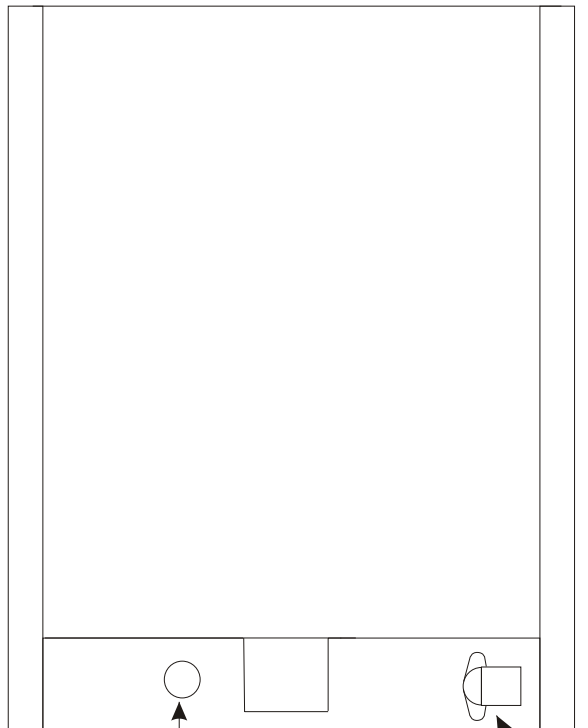

Water inlet

Drain



KINKS

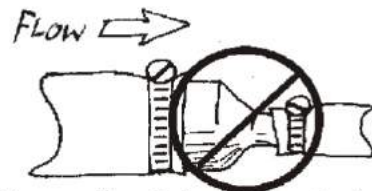

DO NOT REDUCE MORE THAN ONE PIPE SIZE



# Chemical hook-up

This unit is equipped with three (3) chemical pumps; located behind the bottom panel (below the door). Each will inject a different chemical product at a specific time during the wash and rinse cycle. The chemical pumps have sufficient length of tubing hose which can be inserted into gallon size containers, near the dishwasher. The lines can be passed through the center of the dishwasher out either side.

The chemical pumps have colored tubing for ease of identification.

The colors are as follow:

- Red for Detergent
- Clear for Sanitizer
- Blue for Rinse-additive

To prime the pumps; push the toggle switch above each pump until the products have reached the sump.

Suggested chemical use and quantities.

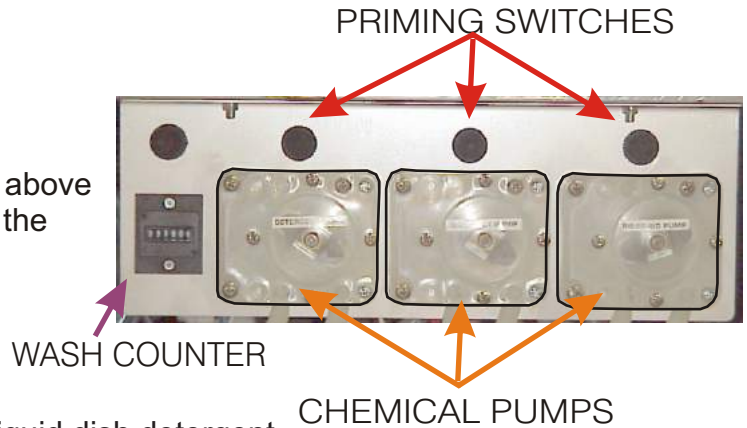

## Detergent:

Extra heavy-duty non-foaming commercial liquid dish detergent required. Adjust to .30% concentration.

## Sanitizer:

Liquid chlorine bleach (sodium hypochlorite - 5.25% solution) adjusted to 50 PPM.

## Rinse-Aid:

Low foam rinse-aid, surfactant isopropanol, adjusted for proper sheeting.

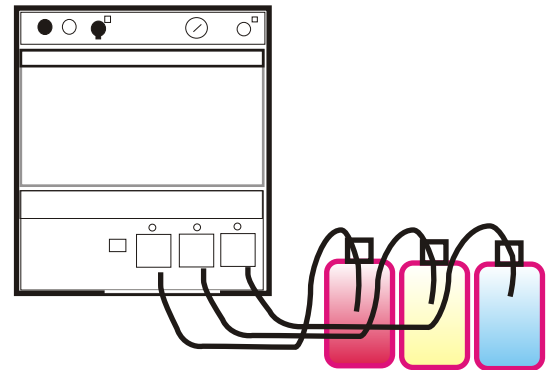

See local health code for appropriate quantities and usage.  
Contact your chemical representatives for calibration and supply.

## WARNING

Whenever manipulating chemicals, use appropriate protection (eyes and hands) as these chemicals are corrosive.



# Installation Check List

- Is the dishwasher connected electrically?
- Is the breaker (in the electrical panel) switched on?
- Is there water connected to the dishwasher?
- Is the water valve opened?
- Are the chemicals properly set?

# Operation

## Fill the dishwasher;

- 1) To begin, you need to turn the **black swivel** switch clockwise a quarter turn to the ON position.
- 2) Fill the wash tank with water by pressing the **round black fill button** (on the left side). Open the door to monitor the water level, push and hold the **black fill button** until the water has reached an inch above the bottom. This needs to be done only if the wash tank is empty. The dishwasher will refill itself automatically at every cycle.

## Begin Loading:

- 3) Load a rack of cups and glasses and slide into the dishwasher. Close the door.
- 4) Press the **cycle button** (black round button on the right) to start the wash cycle.
  - a. The wash and rinse cycle takes 90 seconds. The dishwasher will automatically pump in the proper amount of detergent, rinse-aid and sanitizer.
- 5) Once the cycle is done, the indicator light will switch Off.

## Drain the unit:

At the end of the day, or if the water needs to be emptied, you can drain the dishwasher by pressing and holding the **white button**. You need to hold for several seconds (about 30 seconds).

Note: Do not run the dishwasher without any water.

Make sure the power switch is turned off at night.

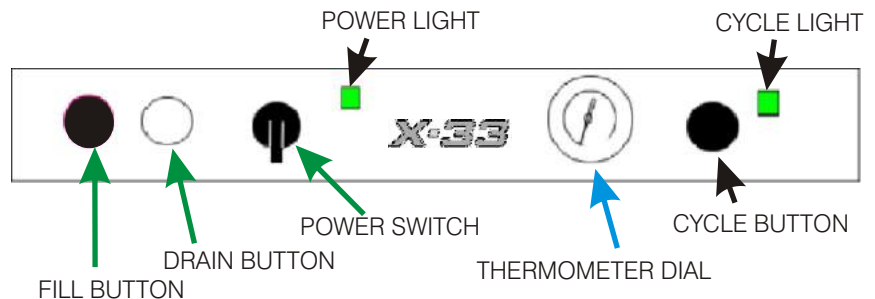

# Maintenance

◆ This dishwasher requires daily maintenance. The most important part is to keep the interior clean. In the sump area, you will find a round screen. This round screen can be removed easily and must be cleaned at least once a day.

◆ Chemical containers should be checked daily for quantity. If they are low on product, replace them.

◆ Depending on the water quality, the dishwasher should have a descaling treatment on a weekly basis. To do a descaling treatment, put a cup (250ml) of descaling solution in the dishwasher once it is filled with water. Run the dishwasher twice.

◆ The spray jets should be inspected for obstruction once a month. If blocked, the upper jets can be unscrewed and cleaned under running water. The rotating spray arm can be removed by unscrewing the center knob.

◆ The bottom panel below the door, should be opened and the chemical pumps checked for leaks also once a month.



# Trouble Shooting

Power is turned on but nothing happens!

> verify the circuit breaker in the building's electrical box. If the unit was installed with a cord and plug, verify that the plug is well placed in the receptacle.

The power is on but the unit will not fill!

> verify that the incoming water shut off valve is opened.

The power is on, the unit is filled with water but it wont start!

> Verify that the door is properly closed.

The Unit is not cleaning!

> Verify the filter inside the wash tank area, it must be cleaned daily. Verify that all chemical bottles are filled and there is no air gap in the chemical tubes. If there is an air gap in the tube, the chemical pump should be primed. See instruction on page 9.

The temperature is too low (below 120F)!

> Verify your hot water supply. The hot water tank may be defective and can not supply hot water to the dishwasher.

The water is overflowing out by the door!

> Verify that the drain hose is not kinked.

If you have tried the recommended action above and the problem remains, call for service.

If the following conditions happen, call for service.

The wash cycle is too long (more than 90 seconds).

The unit is not rinsing the glasses.

The unit will not shut off.

## IMPORTANT NOTES

Locate and clearly identify the water shut-off valve that supplies the dishwasher and the fuse box or breaker switches.

**Only qualified and/or licensed technicians can repair this piece of equipment.**

Removing panels will expose wires and live current. The breaker switch should be switched off or fuses removed before removing the panels. The water supply must also be turned off.



## CONTACT INFORMATION

Phone:  
**1-888-275-4538**  
**514-737-9701**  
Fax:  
**514-737-2792**  
**www.jet-tech.com**  
**service@jet-tech.com**

# Electrical Schematics

1 888 275 4538 - 611  
 514 737 9701 - 611  
 FAX 514 737 2792

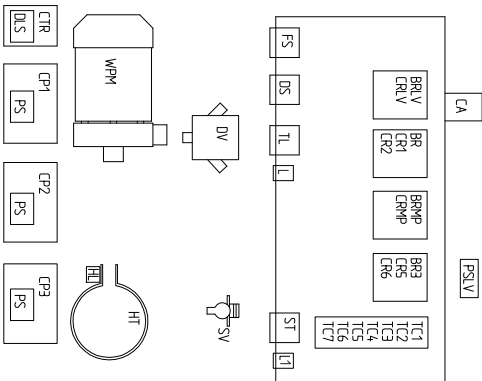
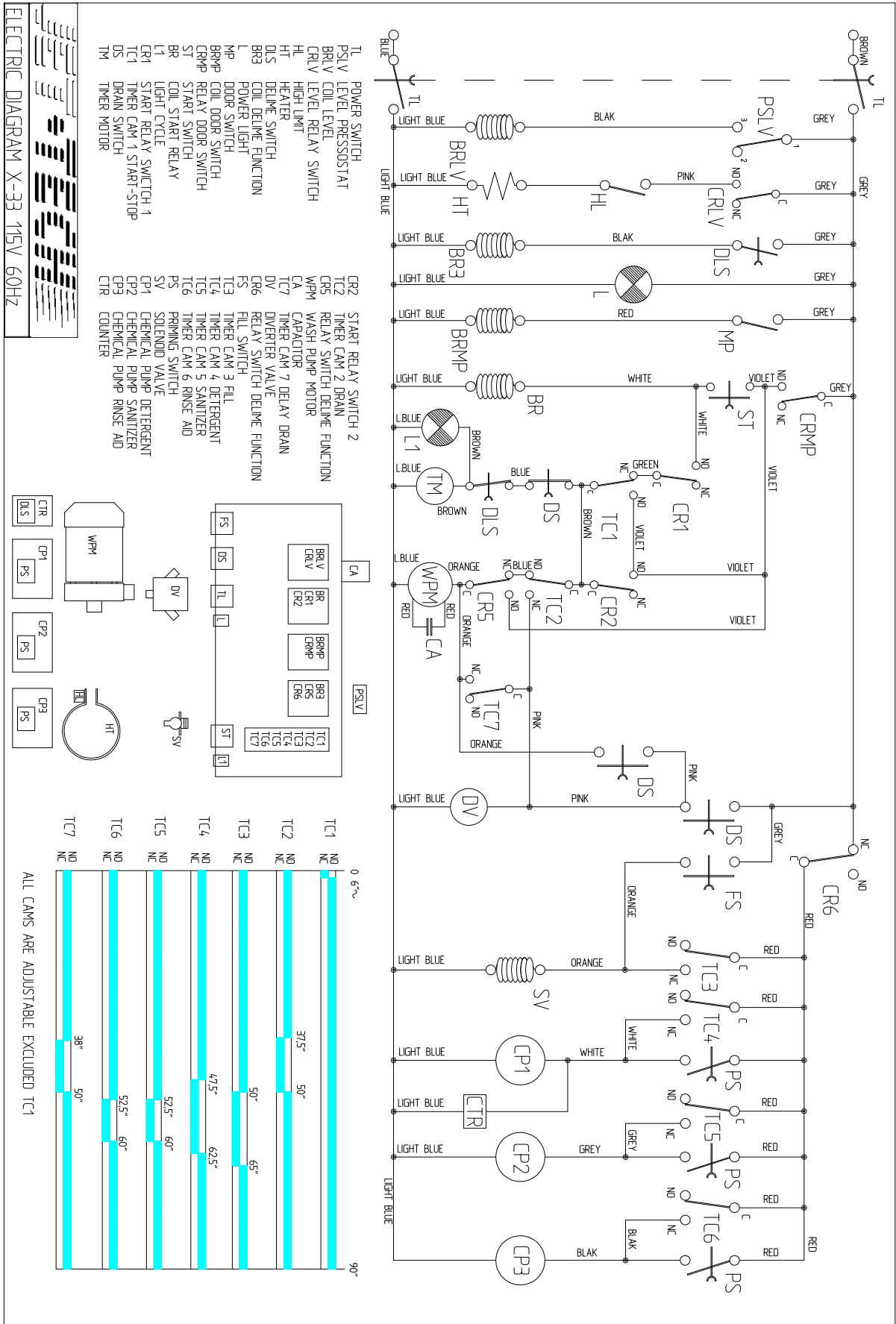

ALL CAMS ARE ADJUSTABLE EXCLUDED TC1

TC	0°	90°
TC1	NO	NC
TC2	NO	NC
TC3	NO	NC
TC4	NO	NC
TC5	NO	NC
TC6	NO	NC
TC7	NO	NC

# Exploded View 1

TAV.No 393 MOD. X-33 JET-TECH

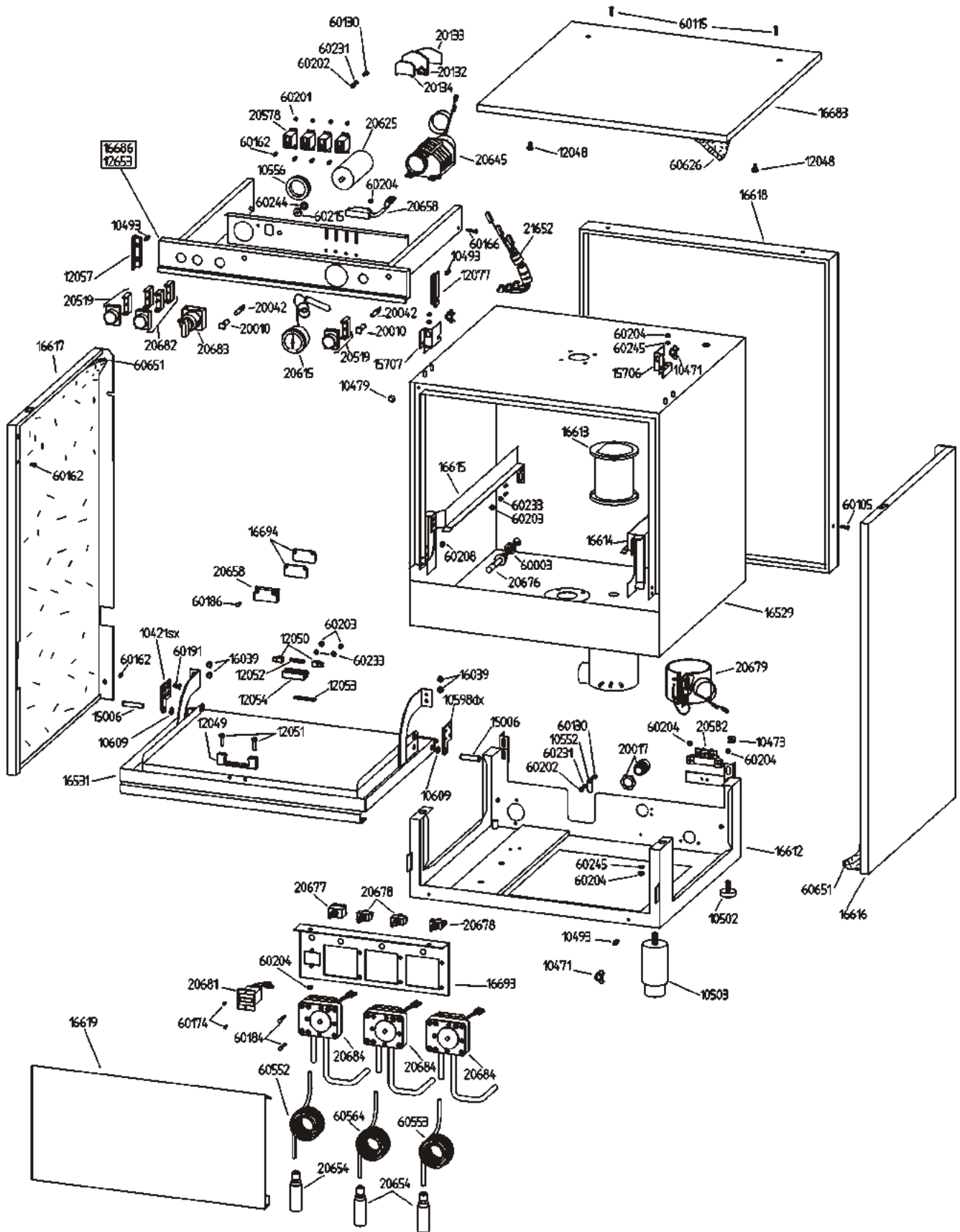

Exploded  
 View 2

TAV. N<sup>o</sup> 394 MOD. X-33 JET-TECH

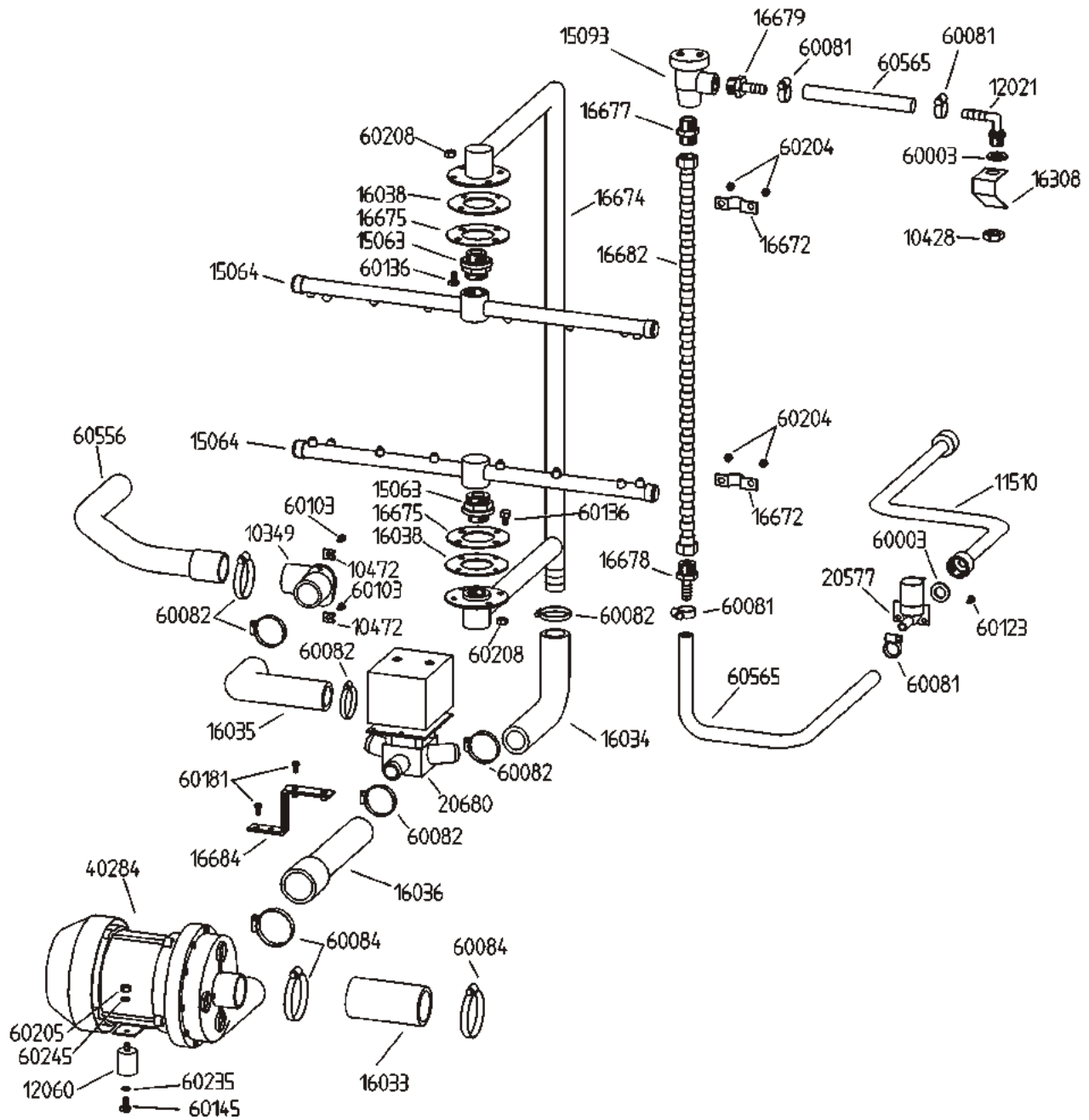



# Parts list

## Articles / Description

10349 CONNECTOR	20577 SOLENOID VALVE 1A 110V UL
10421 SMALL SQUARE	20578 RELAY 12A 110V 60 HZ
10428 NUT	20582 TERMINAL FV110
10471 SPRING	20615 THERMOMETER F 22
10472 SPRING	20618 NOR.OPEN CONTACT F.PUSH BUTTON
10473 SPRING	20625 CAPACITOR 40
10479 BUFFER	20645 TIMER X-35
10493 PIVOT	20654 FILT.AUT.DET.DOS.5X7 X-32/X-33
10502 ADJUSTABLE FOOT	20658 MAGNETIC SWITCH
10503 ADJUSTABLE FOOT	20675 TERMINAL BLOCK X-33 JET-TECH
10552 PLATE	20676 WATER LEVEL X-33
10556 FAIR LEAD	20677 LEVER KEY DIVERTER+CAP X-33
10598 SQUARE	20678 LEVER BUTTON+CAP X-33
10609 SPACER	20679 TANK HEATING ELEM.115V 800W
11510 TUBE	20680 DRAIN VALVE X-33
12021 CONNECTOR	20681 CYCLES COUNTER X-33
12048 PIVOT	20682 WHITE DRAIN BUTTON X-33
12049 DOOR HOOK	20683 SWITCH X-33
12050 DOOR CATCH	20684 PERISTALTIC PUMP X-33
12051 BUSH	20689 NOR.CLOSED CONTACT F.PUSH BUT.
12052 SPRING	21652 LOOM X-33 JET-TECH
12053 PLATE	30049 DISH BASKET 50X50
12054 DOOR CATCH BODY	30105 BASKET
12057 HANDLE SOCKET	40284 M.PUMP 115V 0,75HP 60HZ 2265/D
12060 ANTI-VIBRATION	60003 GASKET
12077 HANDLE SOCKET	60081 CLIP
12653 FILM X-33 JET-TECH	60082 CLIP
15006 PIVOT	60084 CLIP
15063 BUSH ARM X-35	60103 SCREW
15064 ARM X-35/X-33	60105 SCREW
15093 ANTI REFLUX DEVICE X-33	60115 SCREW 4MAX30
15706 SQUARE RIGHT GUIDE	60123 SCREW 3,5X13
15707 SQUARE LEFT GUIDE	60130 SCREW
16033 TUBE X-33	60136 SCREW
16034 TUBE X-33	60145 SCREW 6MA X 8
16035 TUBE X-33	60162 SCREW 4MAX8
16036 TUBE X-33	60166 SCREW
16038 FLANGE EPDM 81X61X2 X-33	60174 SCREW 3MAX8
16039 BUFFER FOR FLASK EPDM	60181 SCREW 4MAX10
16308 SQUARE AQUAFRESH	60184 SCREW 4MAX30
16529 TANK X-33	60186 SCREW 4MAX12
16531 DOOR X-33	60191 SCREW
16612 BASEMENT X-33	60201 NUT
16613 FILTER TANK X-33	60202 NUT
16614 RIGHT B.GU.SPLASH GUARD X-33	60203 NUT
16615 LEFT B.GU.SPLASH GUARD X-33	60204 NUT
16616 RIGHT LAT.PANEL X-33	60205 NUT
16617 LEFT LAT.PANEL X-33	60208 NUT
16618 REAR PANEL X-33	60215 NUT
16619 PANEL X-33 JET-TECH	60231 WASHER
16672 U BOLT HOSE X-33	60233 WASHER
16674 WASH COLUMN X-33	60235 WASHER
16675 COUNTER-FLANGE WASH COL.X-33	60244 WASHER
16677 NIPLO X-33 1/2" PG13 1/2-1/8"	60245 WASHER
16678 RUBBER-CARRIER 1/2" CORR.PIPE	60552 RED HOSE 5X7 X-32/X-33
16679 RUBBER-CARRIER PG13 1/2-18/1"	60553 BLUE HOSE 5X7 X-32/X-33
16682 CORRUGATED PIPE+NUT+GASK.X-33	60556 TUBE FOR DRAIN PUMP
16683 TOP X-33	60564 HOSE 5X7
16684 Z SQUARE SOLENOID VALVE X-33	60565 HOSE
16686 PANEL X-33	60580 INSTRUCTION BAG
16693 FLASK X-33	60583 BAG
16694 MICROSWITCH PLATE X-33	60596 BAG
20010 LIGHT	60626 PANEL
20017 FIXING CABLE	60651 PANEL RIG./LE.SIDE CF 50-70
20042 LIGHT	60655 PACKAGE F 18/737 JET-TECH
20132 TERMINAL	60657 PEDESTAL F 18/737 JET-TECH
20133 PLATE 249-116	60659 EXPANTED 85X10X10X3
20134 TERMINAL 281-313	60675 EXPANTED 87X42X3 K20
20519 PUSH BUTTON	



