

30" PRO-STYLE® RANGETOP

JGCP430WP – 29¾" x 14⅝" x 28⅜"

PRODUCT DIMENSIONS

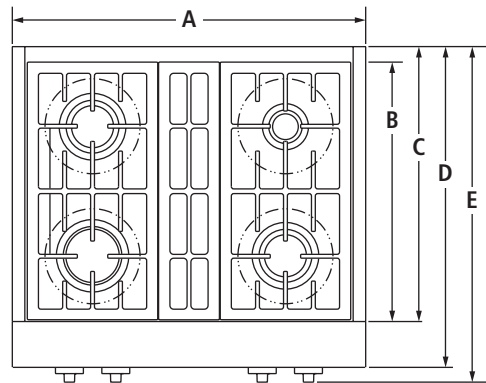

TOP VIEW

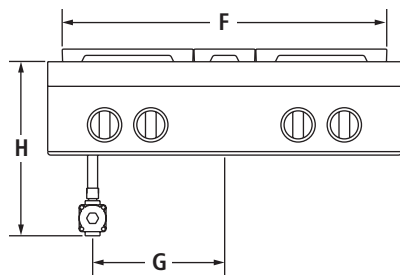

FRONT VIEW

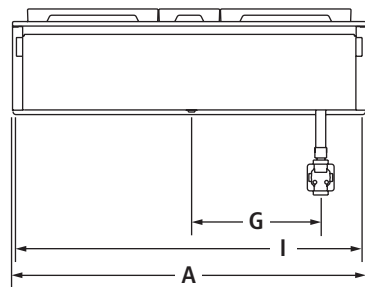

BACK VIEW

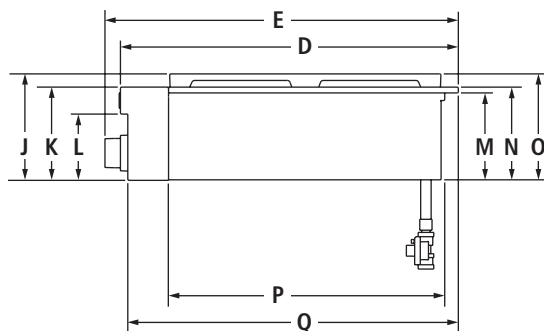

SIDE VIEW

MODEL #		JGCP430WP	
		in	cm
A	Overall width	29¾	75.6
B	Depth of grates	21¾	55.2
C	Depth without control panel	23¼	59.0
D	Depth with control panel overhang	27⅞	68.9
E	Depth with knobs	28⅜	72.0
F	Width of grates	27	68.6
G	Center of rangetop to center of gas inlet	11	28.1
H	Height from gas inlet to cooking surface	14⅝	37.1
I	Width of recessed rangetop	29⅞	73.9
J	Height including grates	8½	21.7
K	Height of control panel	7½	19.0
L	Height to bullnose	5⅞	13.5
M	Height of recessed rangetop	7	17.7
N	Height to cooking surface	7⅞	18.8
O	Height of recessed rangetop with grates	8½	21.6
P	Depth of recessed rangetop	22⅞	56.3
Q	Depth with control panel	26½	67.3

IMPORTANT: Dimensional specifications are provided for planning purposes only. Do not make any cutouts based on this information. Refer to the Installation Guide before selecting cabinetry, verifying electrical/gas connections, making cutouts or beginning installation. All Jenn-Air® appliances are appropriately UL, CUL or CSA approved.

30" PRO-STYLE® RANGETOP

JGCP430WP – 29¾" x 14⅝" x 28⅜"

OPENING/CLEARANCE DIMENSIONS

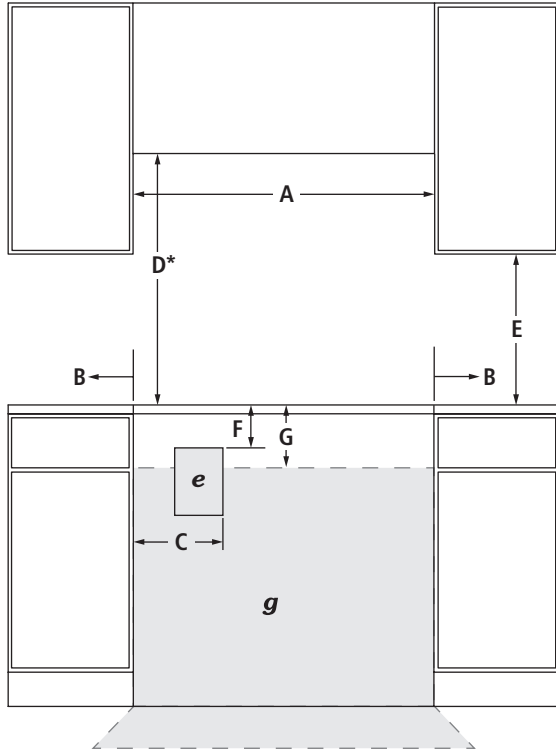

FRONT VIEW

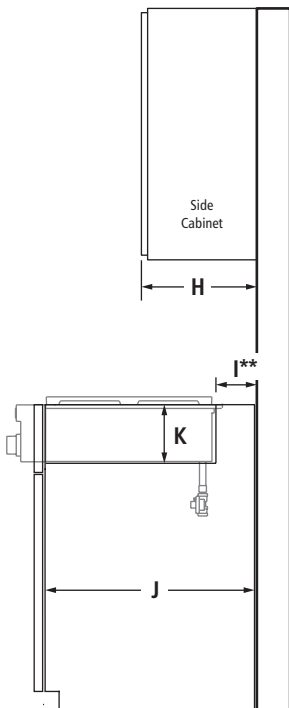

SIDE VIEW

MODEL #	JGCP430WP	
	in	cm
A	Width of combustable area above cooking surface (min.)	30 76.2
B	Width from rangetop to fixed wall or other combustable material (min.)	6 15.2
C	Width to inner edge of outlet (max.)	16 40.6
D*	Height to bottom of uncovered wood or metal cabinet above cooking surface (min.)	30 76.2
E	Height to bottom of uncovered wood or metal cabinet (min.)	18 45.7
F	Height to top edge of outlet (min.)	10 25.4
G	Height to gas supply line area	14 35.6
H	Depth of upper cabinet (recommended)	13 33.0
I**	Depth from cutout to wall	1¾ 4.4
J	Depth of cabinet	24 61.0
K	Height from cabinet to countertop	7¼ 18.4
L	Width of cutout (countertop and cabinet)	29¼ 74.3
M	Width of gas opening	12½ 31.7
N	Width from cutout to gas opening	2 5.1
O	Width of notch	⅜ 1.0
P	Zero clearance	⅝ 0.8
	Width of cutout (countertop only)	30 76.2
Q	Zero clearance	29⅞ 75.9
	Depth of gas opening	6⅞ 17.5
R	Depth from cutout to gas opening	¾ 1.9
S	Depth of cutout (countertop and cabinet)	22¼ 56.5
e	Recommended electrical outlet location	
g	Recommended gas supply line location	

*Dimension can be reduced by 6" (15.2 cm) when bottom of wood or metal cabinet is covered by not less than ¼" (0.6 cm) flame retardant millboard covered with not less than No. 28 MSG sheet metal, 0.015" (0.4 mm) stainless steel, 0.024" (0.6 mm) aluminum or 0.020" (0.5 mm) copper.

If installing a hood above the rangetop, follow the hood instructions for dimensional clearances above the cooking surface.

**If back wall is constructed of a combustable material and a backsplash is not installed, a 1¾" (4.4 cm) minimum clearance is required.

GAS REQUIREMENTS

Natural Gas

This rangetop is factory-set for use with natural gas.

LP Gas Conversion

Conversion must be done by a qualified service technician. To convert to LP gas, use the LP gas conversion kit provided with the rangetop.

ELECTRICAL REQUIREMENTS

120 volt, 60 Hz, AC only, 15-amp fused, electrical circuit is required. A time-delay fuse or dedicated circuit is recommended.

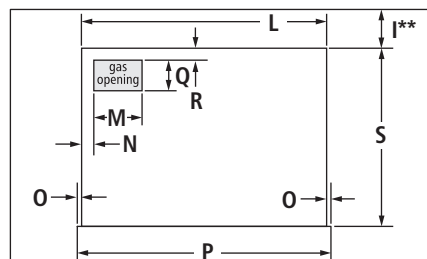

TOP VIEW – CUTOUT
(solid platform not shown)

IMPORTANT: Dimensional specifications are provided for planning purposes only. Do not make any cutouts based on this information. Refer to the Installation Guide before selecting cabinetry, verifying electrical/gas connections, making cutouts or beginning installation. All Jenn-Air® appliances are appropriately UL, CUL or CSA approved.

