

BERTAZZONI PROFESSIONAL SERIES

30" BUILT-IN BOTTOM MOUNT LEFT SWING DOOR

REF30PIXL + PROHK30PI

HIGHLIGHTS

• FlexMode Refrigerator-Freezer

Switch bottom compartment between freezer and refrigerator with one touch.

• Digital User Interface

Internal LED touch interface with intuitive controls for temperature management and all system functions.

• Custom ice maker & water filtration

Integrated water filter connected to water line ensures regular production of ice cubes of customizable size.

• Interior LED lighting

Extra-bright LED lighting on top and sides provide optimized interior illumination on all levels with minimal energy consumption.



FEATURES

Style	bottom mount
Finish	stainless steel
Handle styles	Professional series
Interface	digital display inside
Lighting	6 LED lights recessed into refrigerator ceiling, 5 side wall flush mounted individual
Refrigerator shelves	2 full-width
Refrigerator drawers	2
FlexMode drawers	1 large drawer, 1 inner drawer + ice tray
Door storage compartment	3 full-width racks
Ice maker	automatic, up to 3lbs/24 hours
U.S. DOE annual energy consumption	575 kWh/yr
Automatic settings	Max Cool Fridge, Vacation, Beverage Cooler, SuperIce, IceSize, Sabbath Mode, Water Filter

TECHNICAL SPECIFICATIONS

Voltage , frequency	115V, 60Hz
Max Amp Usage, power rating	4.8A, 552W
DOE compliant	yes
Power connection	back side, length of power cord 6.5ft
Water connection	back side, water supply tube (female attachment) 3/4"
Certification	ETL
Warranty	2 years parts and labor
CAPACITY	
Refrigerator capacity	11 cu.ft
FlexMode capacity	2.9 cu.ft
Total capacity	13.9 cu.ft

BERTAZZONI PROFESSIONAL SERIES

30" BUILT-IN BOTTOM MOUNT LEFT SWING DOOR

REF30PIXL + PROHK30PI

INSTALLATION INSTRUCTIONS

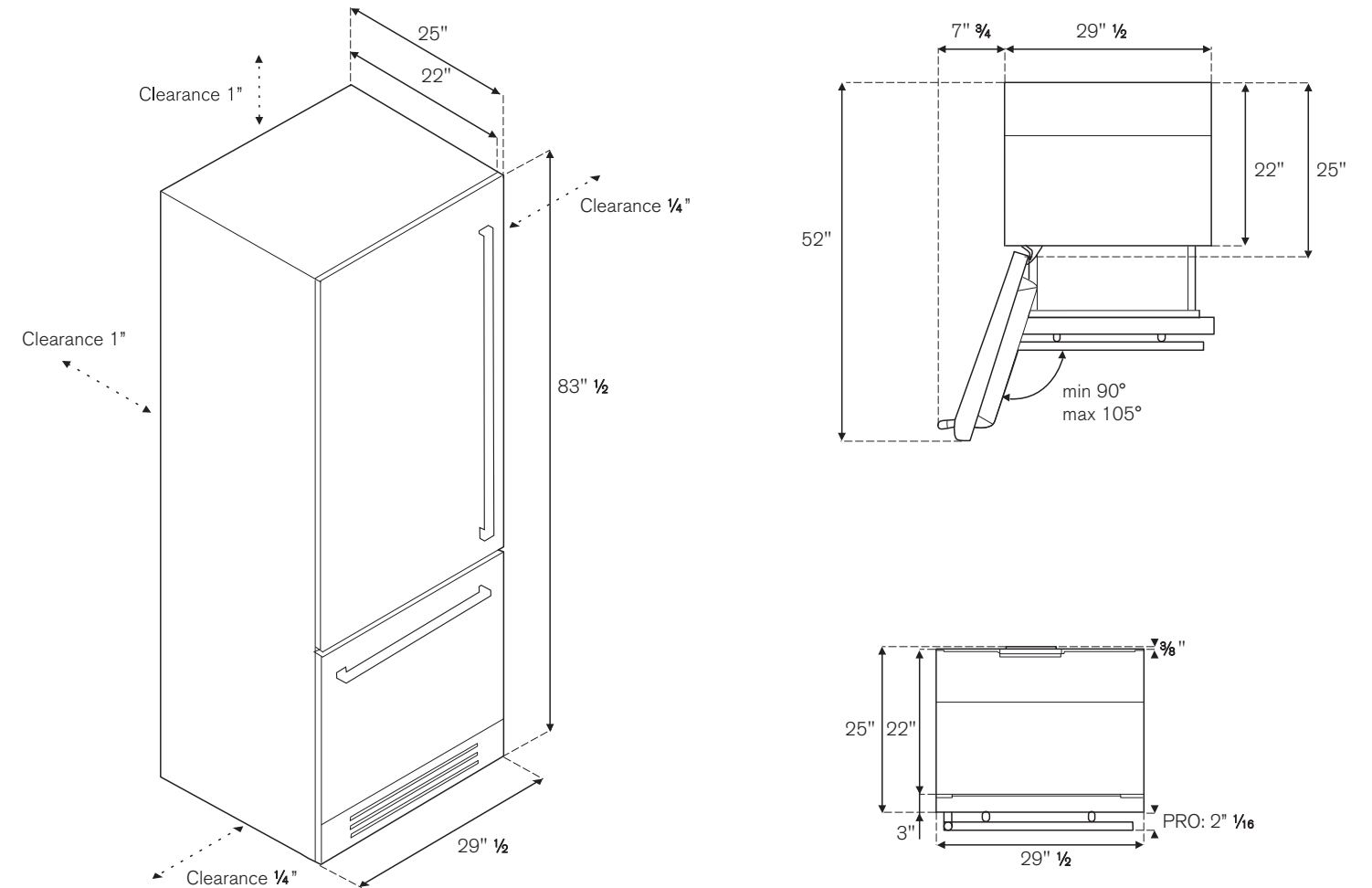

INSTALLATION: There shall be a space not less than 1 inch from the top of your refrigerator, not less than 1/4 inch from both sides and 1 inch or more from the back of the refrigerator to the adjacent walls respectively. This requirements is good for open and close of the door and also for heat emission.

DIMENSIONS

Depth with handles	27 1/16"
Depth without handles	25"
Depth corpus	22"
Height	83 1/2"
Width	29 1/2"

Refrigerator handles are provided separately with dedicated commercial code and packaging.

Disclaimer: while every effort has been made to insure the accuracy of the information contained in this brochure, Fratelli Bertazzoni reserves the right to change any part of the information at any time without notice.

Fratelli Bertazzoni, Bertazzoni and the winged wheel brand icon are registered trademarks of Bertazzoni Spa.

WWW.BERTAZZONI.COM



TO COOK BEAUTIFULLY
WWW.BERTAZZONI.COM