



Installation Plan
Commercial Rotary Iron
PM 1210
PM 1214
PM 1217

To avoid the risk of accidents or damage to the machine, it is **essential** to read these instructions before it is installed and used for the first time.

en - US

Contents

Notes for installer	3
Installation	3
Setting up the rotary iron.....	4
Mounting the toe-kick (optional).....	4
Install the laundry box on the laundry outfeed table.	4
Duct for venting steam	4
Substitute duct lengths	5
Maximum permissible total duct length	5
Electrical connection	6
Installation Plan	7
Flatwork ironer PM 1210, PM 1214, PM 1217	7
Technical details	8

The rotary iron should be installed by a Miele trained installer.

Storage of the machine

The following conditions must be observed for transport and storage:

Temperature: minimum of - 77°F / 25°C to maximum of 131°F / 55°C

Humidity: minimum of 5% to maximum of 75%, non-condensing

Maximum storage period: 2 years

Operating conditions

In general, the operating conditions of DIN 60204 and EN 60204-1 apply.

Temperature and relative humidity

Temperature: 40°F / 5°C - 104°F / 40°C

Relative humidity: 10% - 85%

At 70°F (21°C) ambient temperature, the maximum permissible relative humidity is 70%.

⚠ Do not operate the machine in a room where cleaning machines operate with solvents containing PERC or CFC. Motor sparking may convert solvent vapors into hydrochloric acid which can lead to consequential damage.

Installation

The machine is transported to the installation site while still in the packaging. Do not remove the packaging until right before installation.

The machine may be transported or lifted from the wooden frame only with the lateral mounting flaps mounted.

First lift the machine at the installation site by the wooden frame. The suspension points for lifting hooks/straps are located under the side columns between the screw-on feet.

During installation, remember that the clearance next to and behind the machine columns must amount to at least 23 5/8" (600mm) so that the side plates remain accessible.

The machine should be set up so that the light shines parallel to the infeed table as much as possible.

The clearance in front of the machine must amount to at least 60" (1.5m) to prevent a heating of foreign materials (furniture, walls). There should be a clearance of at least 39" (1m) above the machine.

A base and anchoring means are not necessary.

During the transport of the machine, pay attention to its stability. The iron may not be transported without the wooden frame (e.g., in case of a move). For a new transport, lift the iron onto the wooden frame and fasten it there.

Notes for installer

Setting up the rotary iron

- Dismantle the mounting flaps on the left and right sides.
- Check the roller and front and outside of the side columns using a level.
- Align the machine using the screw-on feet in such a way that the side columns and roller are level with each other. In the process, the feet may be unscrewed a maximum of 2 3/8" (60mm).
- Counter the screw-on feet according to the alignment using the nuts (under the side columns).

Mounting the toe-kick (optional)

Mounting the optionally available toe-kick can raise the machine by 4" (100mm).

- Dismantle the mounting flaps on the left and right sides.
- Unscrew the screw-on feet by the maximum amount (> 2 3/8" (60mm)).
- Hold the side columns with a suitable aid and remove the screw-on feet.
- Mount the screw-on feet into the toe-kick and push the toe-kick under the column.
- Screw the toe-kick to the base plate of the machine.

Install the laundry box on the laundry outfeed table.

- During installation, bring the laundry shelf into a horizontal position.
- Loosen the fastening screws of the laundry shelf.
- Rotate the laundry box by 180° and mount with the fastening screws on the laundry outfeed table.

Duct for venting steam

⚠ Never connect an exhaust hood to an active chimney, dryer vent, flue, or room venting ductwork. It must also be laid separately to any exhaust air duct used for a laundry dryer.

The moist warm exhaust air must be vented to the outdoors by the shortest route possible. To ensure optimum air flow, the ducting should contain as few bends as possible and airtight connections. Filters and louvers may not be installed into the exhaust duct.

Since the relative humidity can amount to up to 100%, suitable measures must be taken to prevent condensate from flowing back into the machine. If the available pressure of the machine fan for overcoming conductor resistance does not suffice, an according dimensioned additional fan must be installed in the shaft or roof outlet on-site. Ensure that there is sufficient ventilation in the room where the ironer is installed

- The connection for the exhaust air duct for steam extraction (optional for PM 1210) is located on the rear of the left side column and has a diameter of 2 3/4" (70mm).
- The exhaust air duct must have an internal diameter of 2 3/4" (70mm).
- To prevent the build-up of condensation in an upward sloping exhaust ducting, a 1/8" - 3/16" (3-5mm) ø condensate trap should be fitted at the lowest point.
- Ensure that there is sufficient ventilation in the room where the ironer is installed
- The on-site ducting system and the exit point to the outside must be checked on a regular basis for a build-up of lint and cleaned if required.
- The air duct leading into the open should be protected against the elements, e.g. using a suitable hood or grille or with a 90° bend.

Substitute duct lengths

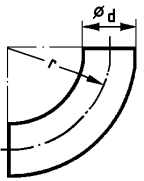
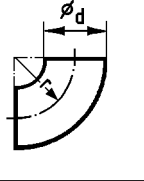
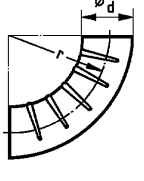
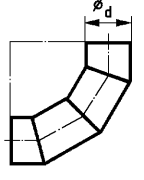
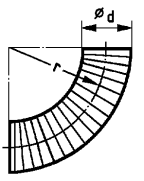
Molded part			Substitute duct length
			PM 1210* PM 1214 PM 1217
	90° bend	$r = 2 d$	10" (0.25m)
	45° bend	$r = 2 d$	5 7/8" (0.15m)
	90° bend	$r = d$	13 3/4" (0.35m)
	45° bend	$r = d$	10" (0.25m)
	90° creased bend	$r = 2 d$	27 9/16" (0.7m)
	45° creased bend	$r = 2 d$	21 5/8" (0.55m)
	90° segmental bend (3 weld seams)	$r = 2 d$	17 11/16" (0.45m)
	45° segmental bend (3 weld seams)	$r = 2 d$	-
	90° bend made of flexible duct	$r = d$	-
		$r = 2 d$	19 11/16" (0.5m)
		$r = 4 d$	13 3/4" (0.35m)
	45° bend made of flexible duct	$r = d$	-
		$r = 2 d$	15 3/4" (0.4m)
		$r = 4 d$	11 13/16" (0.3m)

According to the number of bends, the substitute duct lengths must be deducted from the maximum permissible duct length.

Maximum permissible total duct length

Adequate room ventilation must be ensured during operation.

Minimum inside duct diameter (sheet metal ducting)	Maximum permissible total duct length Exhaust air
	PM 1210* PM 1214 PM 1217
2 3/4" (70mm)	16' 4 7/8" (5m)
3 1/8" (80mm)	65' 7 3/8" (20m)
3 9/16" (90mm)	104' 11 13/16" (32m)
4" (100mm)	131' 2 13/16" (40m)

*Optional extraction fan

⚠ Once the machine has been successfully installed and connected, replace all the external parts that were removed.

Notes for installer

Electrical connection

All electrical work must be performed by a qualified service technician in accordance with all applicable codes and standards.

- The electrical connection and wiring diagram are located behind the mounting flap of the right side column.
- The values for the electrical connection and fuse rating can be found on the data plate (see the "Technical data" chapter in this document).
- If the appliance is hard wired, a multiple-pole separator must be installed. Separators with a contact gap of more than 1/8" (3 mm) are valid as separators. All components have to bear CSA or UL approval.
- The plug connection or the disconnecter must be accessible at all times.
- You must be able to lock the disconnecter or monitor the point of disconnection at all times in case the appliance has to be disconnected from the power supply.

Flatwork ironer PM 1210, PM 1214, PM 1217

Type of heating: electrical

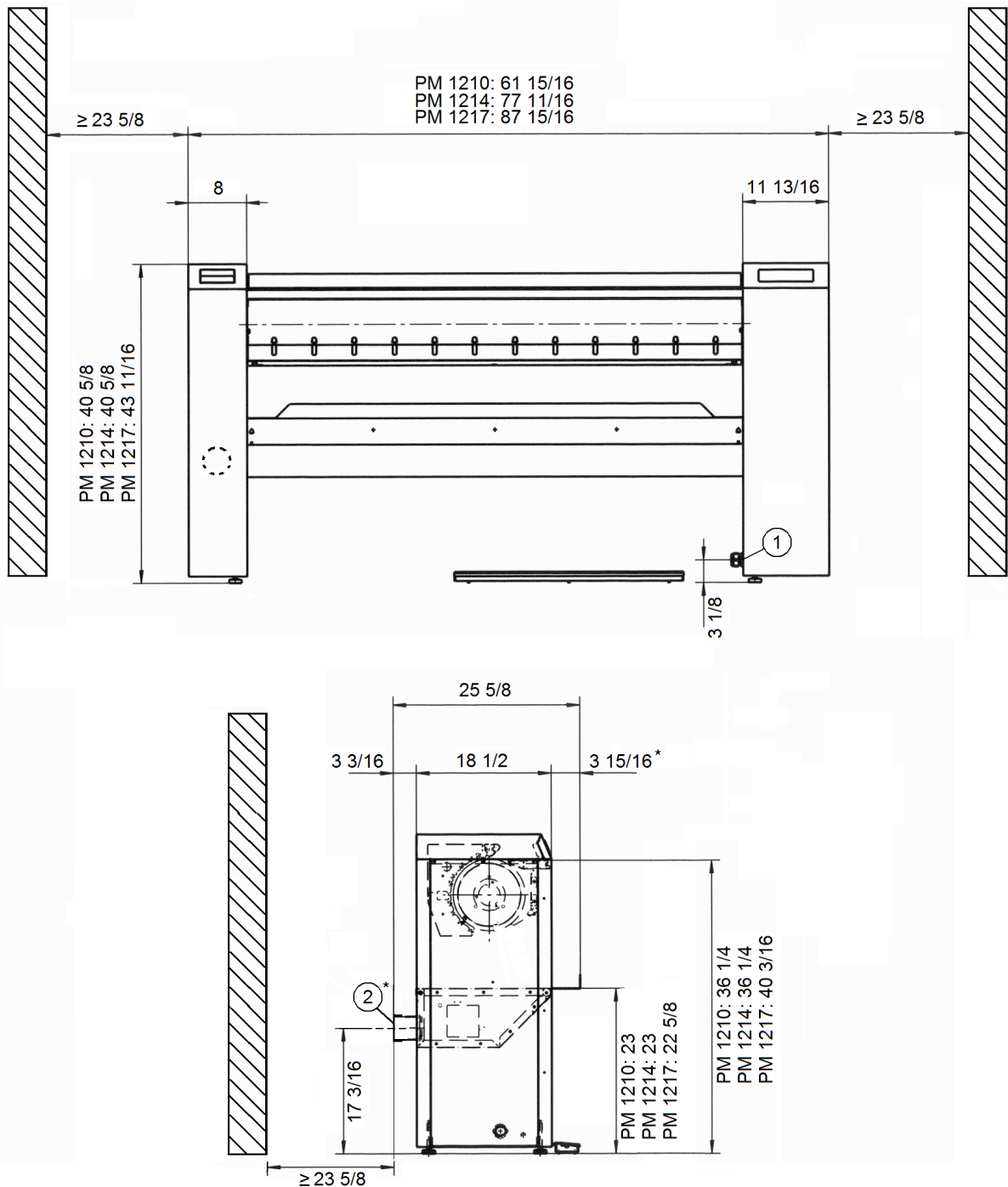

Measurements in inches

* = Option for PM 1210

① Electrical connection

② Exhaust connection

Technical details

		53121005USA, PM 1210 EL USA 3AC 240/220/208V 50-60Hz	09/2014
Voltage		3 AC 240/220/208V 50-60Hz	
Fuse rating		3 x 20 A	
Roller length		39 ³ / ₈ " / 1000 mm	
Roller diameter		8 ⁸ / ₃₂ " / 210 mm	
Type of heating		Electric	
Overall machine dimensions	Width	61 ¹⁵ / ₁₆ " / 1573 mm	
	Depth	18 ¹ / ₂ " / 470 mm	
	Height	40 ⁵ / ₈ " / 1032 mm	
Minimum wall distance, lateral		23 ⁵ / ₈ " / 600 mm	
Minimum wall distance, rear		23 ⁵ / ₈ " / 600 mm	
Net weight		269 lbs (122 kg)	
Max. load bearing in operation		1235 N	
Total connected load		5.3/5.0/4.1 kW	
Heat output, electrical		4.9/4.1/3.7 kW	
Drive output, roller		0.35 kW	
Fan output		-	
Electrical connection		4 x AWG 10 / 4 x 4 mm ²	
Exhaust air connection		-	
Ironing output		56.2 lbs/h / 25.5 kg/h	
Roller	Speed	2.3 - 6.1 rpm	
	Outer circumference linear speed	4' 11" - 13' 1" fpm (1.5 - 4.0 m/min)	
	Contact pressure	1.02 psi / 0.7 N/cm ²	
Fan air output		-	
Max. permitted pressure loss		-	
Material	Side columns	Stove-finished, galvanized sheet steel	
	Roller	Galvanized sheet steel	
	Heater plate	Aluminium, hard-anodized	
Padding		Steel wool	
Material padding		Polyester needle felt with aramid needle felt cloth	
Largest removable part		Laundry outlet table	
Heat dissipation rate at installation site		4.9/4.1/3.7 MJ/h	
Sound pressure level		54 dB (A)	
Sound power level		60.6 dB	

Technical details

Miele PROFESSIONAL		53121006USA, PM 1210 EL USA AC 240/220/208V 50-60Hz	09/2014
Voltage		AC 240/220/208V 50-60Hz	
Fuse rating		2 x 20 A	
Roller length		39 ³ / ₈ " / 1000 mm	
Roller diameter		8 ⁹ / ₃₂ " / 210 mm	
Type of heating		Electric	
Overall machine dimensions	Width	61 ¹⁵ / ₁₆ " / 1573 mm	
	Depth	18 ¹ / ₂ " / 470 mm	
	Height	40 ⁵ / ₈ " / 1032 mm	
Minimum wall distance, lateral		23 ⁵ / ₈ " / 600 mm	
Minimum wall distance, rear		23 ⁵ / ₈ " / 600 mm	
Net weight		269 lbs (122 kg)	
Max. load bearing in operation		1235 N	
Total connected load		3.7/3.2/2.9 kW	
Heat output, electrical		3.3/2.7/2.5 kW	
Drive output, roller		0.35 kW	
Fan output		-	
Electrical connection		3 x AWG 10 / 3 x 4 mm ²	
Exhaust air connection		-	
Ironing output		49.6 lbs/h / 22.5 kg/h	
Roller	Speed	2.3 - 6.1 rpm	
	Outer circumference linear speed	4' 11" - 13' 1" fpm (1.5 - 4.0 m/min)	
	Contact pressure	1.02 psi (0.7 N/cm ²)	
Fan air output		-	
Max. permitted pressure loss		-	
Material	Side columns	Stove-finished, galvanized sheet steel	
	Roller	Galvanized sheet steel	
	Heater plate	Aluminium, hard-anodized	
Padding		Steel wool	
Material padding		Polyester needle felt with aramid needle felt cloth	
Largest removable part		Laundry outlet table	
Heat dissipation rate at installation site		3.3/2.8/2.5 MJ/h	
Sound pressure level		54 dB (A)	
Sound power level		60.6 dB	

Technical details

		53121405USA, PM 1214 EL USA 3AC 240/220/208V 50-60Hz	09/2014
Voltage		3 AC 240/220/208V 50-60Hz	
Fuse rating		3 x 30 A	
Roller length		55 ¹ / ₈ " / 1400 mm	
Roller diameter		8 ⁹ / ₃₂ " / 210 mm	
Type of heating		Electric	
Overall machine dimensions	Width	77 ¹¹ / ₁₆ " / 1973 mm	
	Depth	25 ⁵ / ₈ " / 651 mm	
	Height	40 ⁵ / ₈ " / 1032 mm	
Minimum wall distance, lateral		23 ⁵ / ₈ " / 600 mm	
Minimum wall distance, rear		23 ⁵ / ₈ " / 600 mm	
Net weight		309 lbs (140 kg)	
Max. load bearing in operation		318 lbs (1415 N)	
Total connected load		7.6/6.5/5.9 kW	
Heat output, electrical		7.1/6.0/5.3 kW	
Drive output, roller		0.35 kW	
Fan output		0.11 kW	
Electrical connection		4 x AWG 10 / 4 x 4 mm ²	
Exhaust air connection		2 3/4" (70 mm)	
Ironing output		62 lbs/h (28 kg/h)	
Roller	Speed	2.3 - 6.1 rpm	
	Outer circumference linear speed	4.9 - 13.1 fpm (1.5 - 4.0 m/min)	
	Contact pressure	1.02 psi (0.7 N/cm ²)	
Fan air output		67.7 cfm (115 m ³ /h)	
Max. permitted pressure loss		0.01 psi (100 Pa)	
Material	Side columns	Stove-finished, galvanized sheet steel	
	Roller	Galvanized sheet steel	
	Heater plate	Aluminium, hard-anodized	
Padding		Steel wool	
Material padding		Polyester needle felt with aramid needle felt cloth	
Largest removable part		Laundry outlet table	
Heat dissipation rate at installation site		7.1/5.9/5.3 MJ/h	
Sound pressure level		54 dB (A)	
Sound power level		60.6 dB	

Technical details

Miele PROFESSIONAL		53121705USA, PM 1217 EL USA 3AC 240/220/208V 50-60Hz STW	09/2014
Voltage		3 AC 240/220/208V 50-60Hz	
Fuse rating		3 x 50 A	
Roller length		65 3/8" (1660 mm)	
Roller diameter		9 13/16" (250 mm)	
Type of heating		Electric	
Overall machine dimensions	Width	87 15/16" (2233 mm)	
	Depth	26 5/8" (651 mm)	
	Height	43 11/16" (1110 mm)	
Minimum wall distance, lateral		23 5/8" (600 mm)	
Minimum wall distance, rear		23 5/8" (600 mm)	
Net weight		417 lbs (189 kg)	
Max. load bearing in operation		428 lb (1905 N)	
Total connected load		12.4/10.5/9.4 kW	
Heat output, electrical		11.8/9.9/8.9 kW	
Drive output, roller		0.4 kW	
Fan output		0.11 kW	
Electrical connection		4 x AWG 8 / 4 x 6 mm ²	
Exhaust air connection		2 3/4" (70 mm)	
Ironing output		110 lbs/h (50 kg/h)	
Roller	Speed	1.9 - 5.7 ¹ /min	
	Outer circumference linear speed	1.5 - 4.5 m/min	
	Contact pressure	0.72 psi (0.5 N/cm ²)	
Fan air output		67.7 cfm (115 m ³ /h)	
Max. permitted pressure loss		0.01 psi (100 Pa)	
Material	Side columns	Stove-finished, galvanized sheet steel	
	Roller	Galvanized sheet steel	
	Heater plate	Aluminium, hard-anodized	
Padding		Steel wool	
Material padding		Polyester needle felt with aramid needle felt cloth	
Largest removable part		Laundry outlet table	
Heat dissipation rate at installation site		9.0/11 MJ/h	
Sound pressure level		54 dB (A)	
Sound power level		59.7 dB	

Please have the model and serial number
of your appliance available before
contacting Technical Service.

Miele
PROFESSIONAL

U.S.A.

Miele, Inc.

National Headquarters

9 Independence Way
Princeton, NJ 08540
Phone: 800-991-9380
609-419-9898
Fax: 609-419-4241
www.mieleusa.com

**Technical Service & Support
Nationwide**

Phone: 800-991-9380
Fax: 800-220-1348

proservice@mieleusa.com