

COASTER[®]
Fine Furniture

551302

Armless Chair



ASSEMBLY INSTRUCTION



COASTER FINE FURNITURE



20170429

ASSEMBLY INSTRUCTION

PARTS IDENTIFICATION			
A		Armless Chair	1pcs
B		Right Leg	2pcs
C		Left Leg	2pcs

Z	HARDWARE PACKAGE		
1		Washer	12PCS
2		Bolt	12PCS
3		Allen Wrench	1PC

It takes about five minutes to assemble the item.

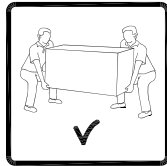

STEP 1

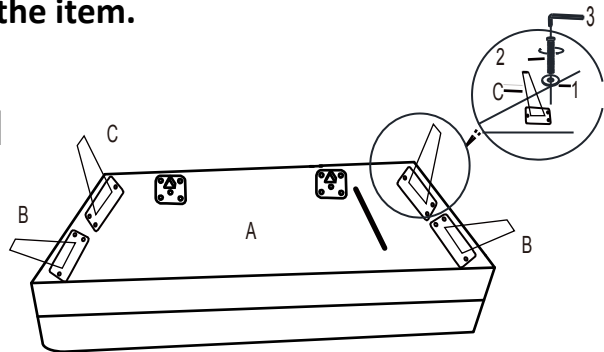

STEP 2

