

COASTER[®]
FINE FURNITURE

200971Q (B1-B3)

QUEEN SIZE BED

ASSEMBLY INSTRUCTIONS
COASTER FINE FURNITURE



www.coastercompany.com

ASSEMBLY TIPS:

1. Remove Hardware from box and sort by size.
2. Please check to see that all hardware and parts are present prior to start of assembly.
3. Please follow attached instructions in the same sequence as numbered to assure fast & easy assembly.



Warning !

1. Don't attempt to repair or modify parts that are broken or defective. Please contact the store immediately.
2. This product is for home use only and not intended for commercial establishment.

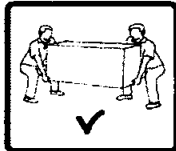

ASSEMBLY TIME

30 MINUTES

PARTS IDENTIFICATION

B1 (BOX 1)

A  HEADBOARD PANEL 1 PC

B  LEFT HEADBOARD LEG 1 PC

C  RIGHT HEADBOARD LEG 1 PC

B2 (BOX 2)

D  FOOTBOARD 1 PC

B3 (BOX 3)

E  BED RAIL 2 PCS

F  BED SLAT 4 PCS

G  BED SLAT SUPPORT WITH LEVELER 4 PCS

HB

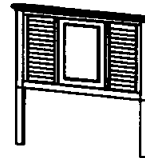





200971Q(B1)
*FROM BOX 1
HEADBOARD COMPLETE 1 PC

D



200971Q(B2)
*FROM BOX 2
FOOTBOARD 1 PC

HARDWARE IDENTIFICATION

1		ALLEN WRENCH	1 PC
2		BOLT	8 PCS
3		LOCK WASHER	8 PCS
4		FLAT WASHER	8 PCS
5		FLAT HEAD SCREW	8 PCS

**NOTE :PHILLIPS HEAD SCREW DRIVER IS REQUIRED IN THE ASSEMBLY PROCESS
HOWEVER , MANUFACTURER DOES NOT PROVIDE THIS ITEM.**

NOTE :ALL HARDWARE WAS PACKED IN A BAG AND PUT IN SIDE RAIL BOX (BOX 3)

200971Q(B1)- BOX 1

STEP 1

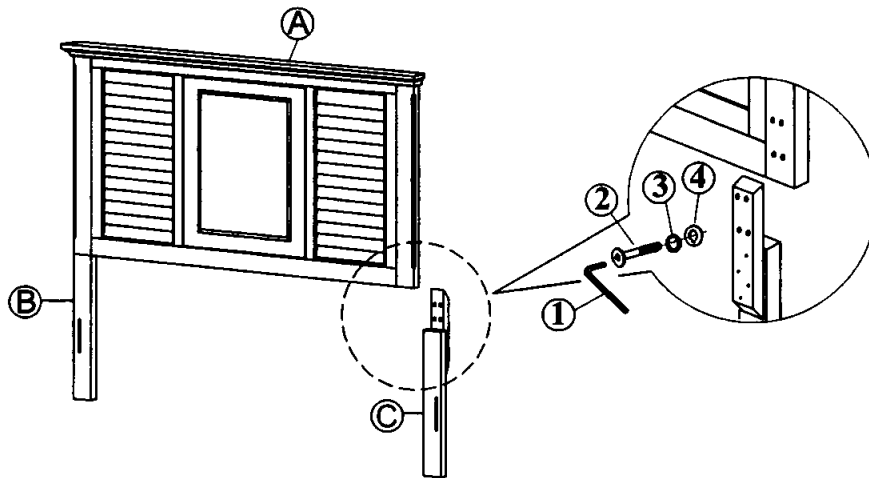

200971Q(B1-B3) - BOX 1 TO BOX 3

STEP 2

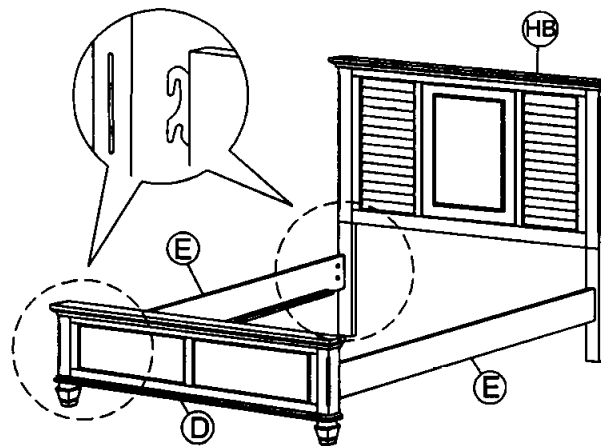

STEP 3

