

COASTER[®]
FINE FURNITURE

910076

SERVING CART

ASSEMBLY INSTRUCTION

COASTER FINE FURNITURE



www.coastercompany.com

ASSEMBLY INSTRUCTION







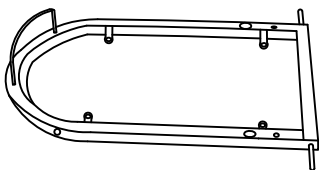
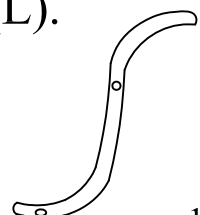
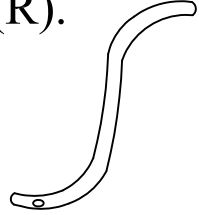
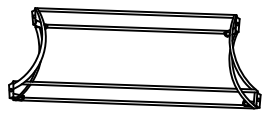
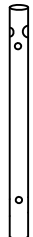
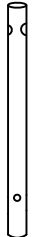
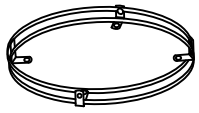
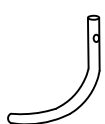

ASSEMBLY TIPS:

- 1.Remove hardware from box and sort by size.
- 2.Please check to see that all hardware and parts are present prior to start of assembly.
- 3.Please follow attached instructions in the same sequence as numbered to assure fast & easy assembly.

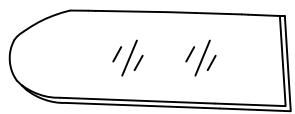

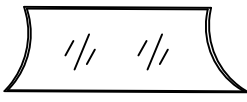

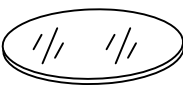



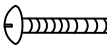
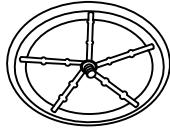
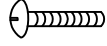

⚠ Warning !

1. Don't attempt to repair or modify parts that are broken or defective. Please contact the store immediately.
- 2.This product is for home use only and not intended for commercial establishment.

PARTS IDENTIFICATION

<p>A.</p>  <p>Lower Frame</p> <p>1PC</p>	<p>G(L).</p>  <p>S Tube(L)</p> <p>1PC</p>	<p>G(R).</p>  <p>S Tube(R)</p> <p>1PC</p>
<p>B.</p>  <p>Square Frame</p> <p>1PC</p>	<p>H(L).</p>  <p>Long Post(L)</p> <p>1PC</p>	<p>H(R).</p>  <p>Long Post(R)</p> <p>1PC</p>
<p>C.</p>  <p>Round Frame</p> <p>1PC</p>	<p>I(L).</p>  <p>Curve Tube(L)</p> <p>1PC</p>	<p>I(R).</p>  <p>Curve Tube(R)</p> <p>1PC</p>
<p>D.</p>  <p>Big Glass</p> <p>1PC</p>	<p>J.</p>  <p>Small Post</p> <p>2PCS</p>	
<p>E.</p>  <p>Small Glass</p> <p>1PC</p>	<p>K.</p>  <p>Handle</p> <p>1PC</p>	
<p>F.</p>  <p>Round Glass</p> <p>1PC</p>	<p>L.</p>  <p>Short Post</p> <p>2PCS</p>	

Z HARDWARE PACKAGE

NO	DESCRIPTION	FIGURE	Q'TY:	NO	DESCRIPTION	FIGURE	Q'TY:
1	Long Bolt(1/4x2")		2PCS	7	Wheel		2PCS
2	Medium Bolt(1/4x1-1/2")		4PCS	8	Caster		2PCS
3	Middle Bolt(1/4x1")		2PCS	9	Large Bead		6PCS
4	Short Bolt(1/4x5/8")		12PCS	10	Small Bead		2PCS
5	Small Bolt(1/4x3/8")		2PCS	11	Wheel Lock		2PCS
6	Suction Cup		12PCS	12	Cap		2PCS

Step 1: Use Long Bolt (1) to fasten two Small Post (J) with Lower Frame (A). And use Medium Bolt (2) to fasten two Short Post (L) with Frame (A) as well. Tighten with a screw driver (not included)

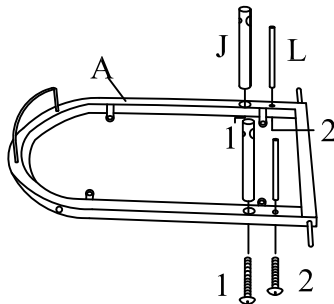

Step 2: Use Middle Bolt (3) to fasten the two S Tubes (G) with Short Post (L). And use Short Bolt (4) to fasten Handle (K) to the S Tube. Tighten with a screw driver (not included)

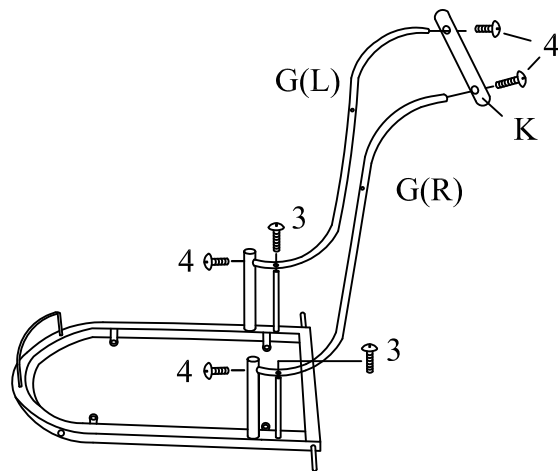

Step 3: Use Medium Bolt (2) to fasten two Long Post (H) to the lower frame. Insert the Cap (12) to the bottom of the post, then put in the Caster (8). Use Small Bolt (5) to fasten Wheel (7) and the Lower Frame, then use Wheel Lock (11) to lock it. Tighten with a screw driver (not included)

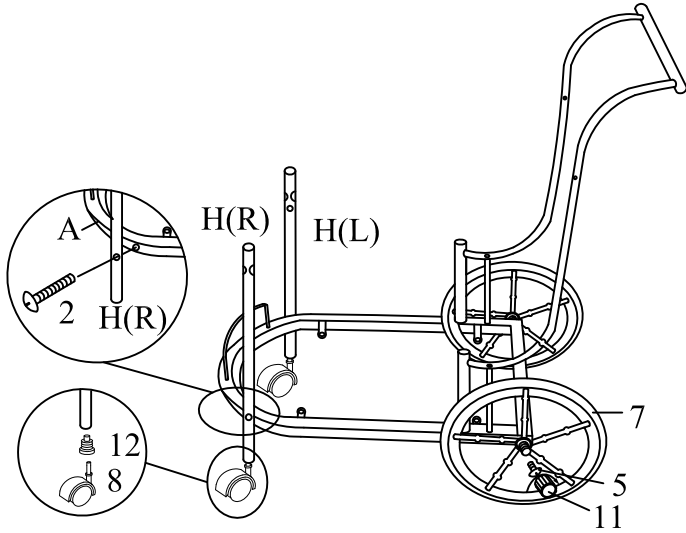

Step 4: Use Short Bolt (4) to fasten Curve Tube (I) to Long Post (H), then use Short Bolt (4) to lock Round Frame (C) between the two Long Post (H). And insert Suction Cap (6) into the frame. Tighten with a screw driver (not included)

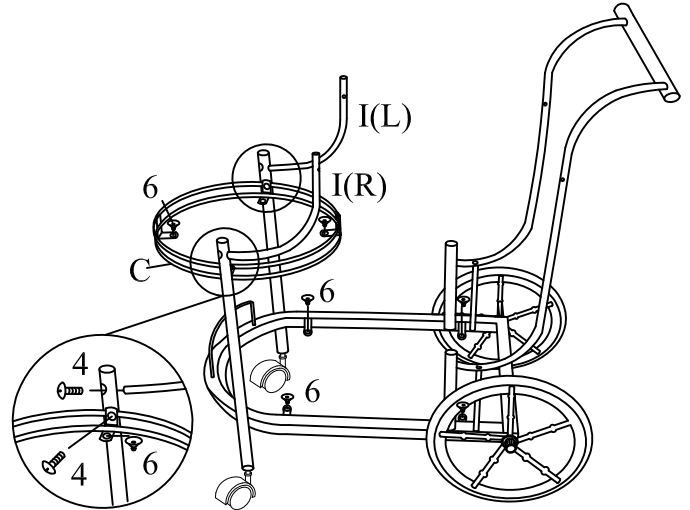

Step 5: Use Short Bolt (4) to lock Square Frame (B) between the two Curve Tube (I) and S Tubes. And insert Suction Cap (6) into the frame. Tighten with a screw driver (not included)

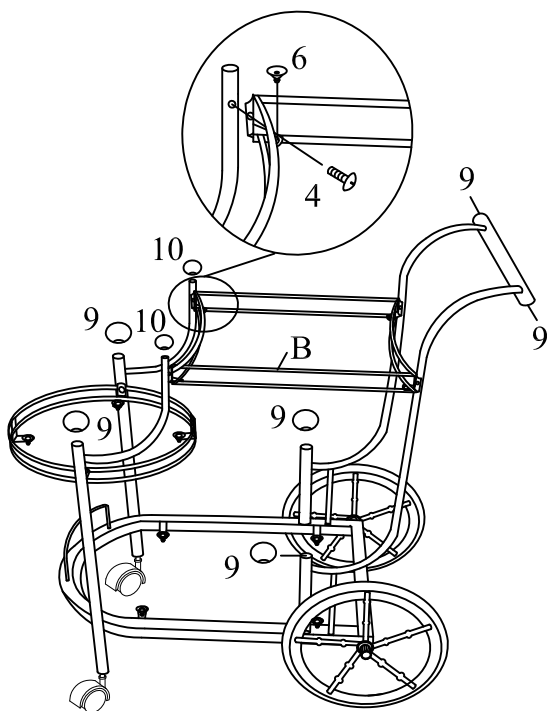

Step 6: Put the Big Glass (D), Small Glass (E) and Round Glass (F) on the frames.

