

COASTER®

Fine Furniture

300515KE

E KING SIZE BED

ASSEMBLY INSTRUCTIONS

COASTER FINE FURNITURE



www.coastercompany.com

1 OF 4

2016-5-3

ASSEMBLY TIPS:

1. Remove hardware from box and sort by size.
2. Please check to see that all hardware and parts are present prior to start of assembly.
3. Please follow attached instructions in the same sequence as numbered to assure fast & easy assembly.

warning

1. Don't attempt to repair or modify parts that are broken or defective please contact the store immediately.
2. This product is for home use only and not intended for commercial establishment.



ASSEMBLY TIME PER UNIT:	10 MINUTES
-------------------------	------------

PARTS IDENTIFICATION

A

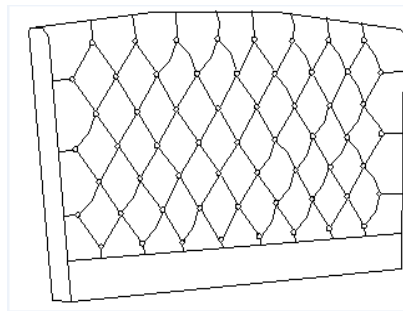

Headboard 1PC

B

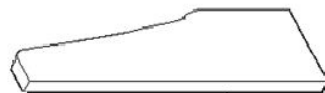

Wing 2 PCS

HARDWARE PACKAGE

1



5*23*67mm

Allen wrench 1 PC

2



Ø5/16 * Ø16 * Ø1.5 mm

Flat washer 6 PCS

3



8*50mm



Long bolt 6 PCS

All above hardware pack is located in 300515KE B1





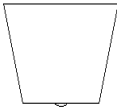
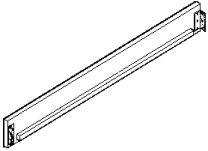
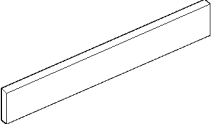

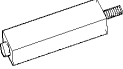

COASTER
Fine Furniture

www.coastercompany.com

PARTS IDENTIFICATION

C		Wood legs	2 PCS
D		Bed rail	2 PCS
E		Footboard	1 PC
F		Slat	5 PCS
G		Support leg	10 PCS

HARDWARE PACKAGE

	DESCRIPTION	FIGURE	Q'TY
1	Allen wrench 5*23*67mm		1 PC
2	Flat washer Ø5/16 * Ø16 * Ø1.5 mm		10 PCS
4	Long bolt 8*70mm		10 PCS
5	Footboard corner bracket		2 PCS
6	Flat washer Ø6.5 * Ø19 * Ø2 mm		12 PCS
7	Short bolt 6*25mm		12 PCS
8	Wood screw		10 PCS
9	Allen wrench 4*23*60mm		1 PC
All above hardware pack is located in 300515KE B2			

STEP 1

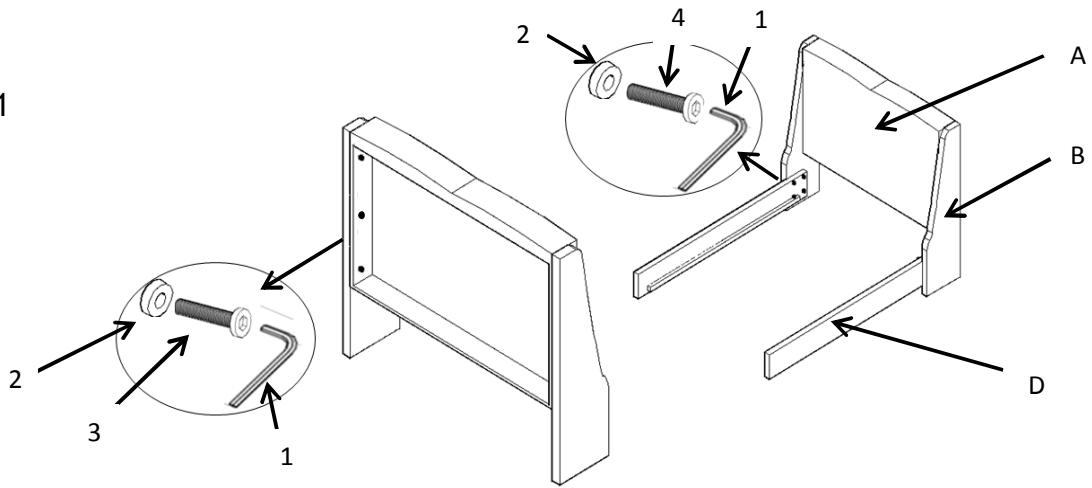

STEP 2

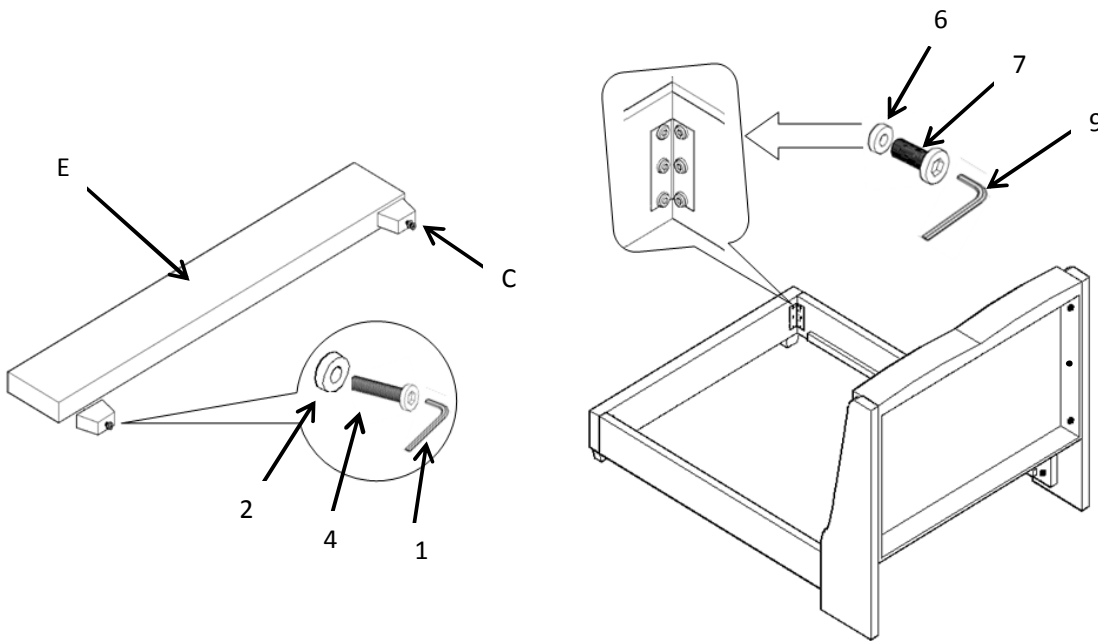

STEP 3

