

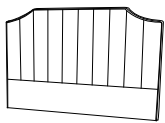

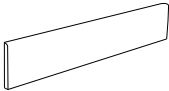

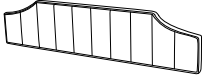



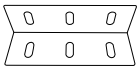
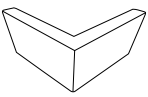

ASSEMBLY INSTRUCTIONS

Components

A		Head board	1
B		Side board	2
C		Foot board	1
D		Bed slat	1
E		Connector	4
F		Leg	4
G		Middle leg	2

Hardware

a		Washer	24
b		Screw	24
c		Screw	16
d		Spanner	1
e		Screw	4
f		Bolt	4

ASSEMBLY STEPS

STEP 1

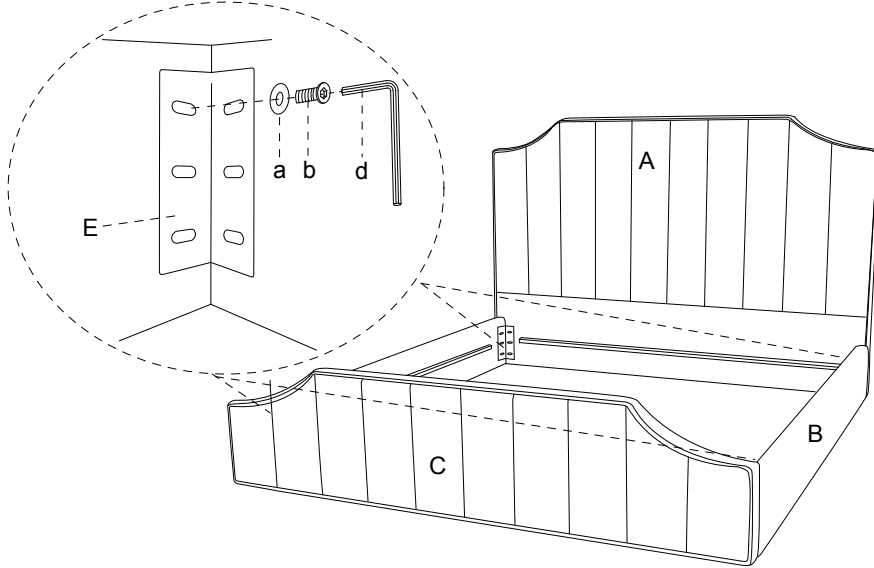

STEP 2

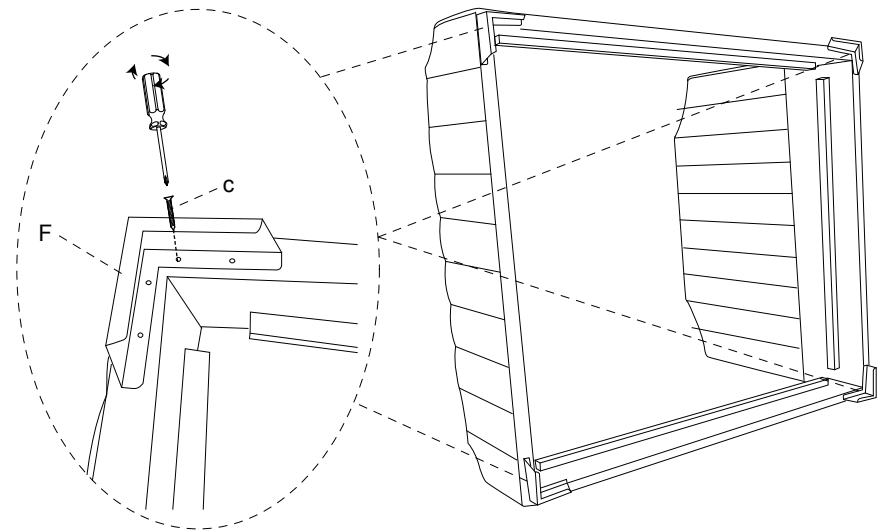

A SCREWDRIVER IS REQUIRED TO ASSEMBLE THE LEGS.

STEP 3

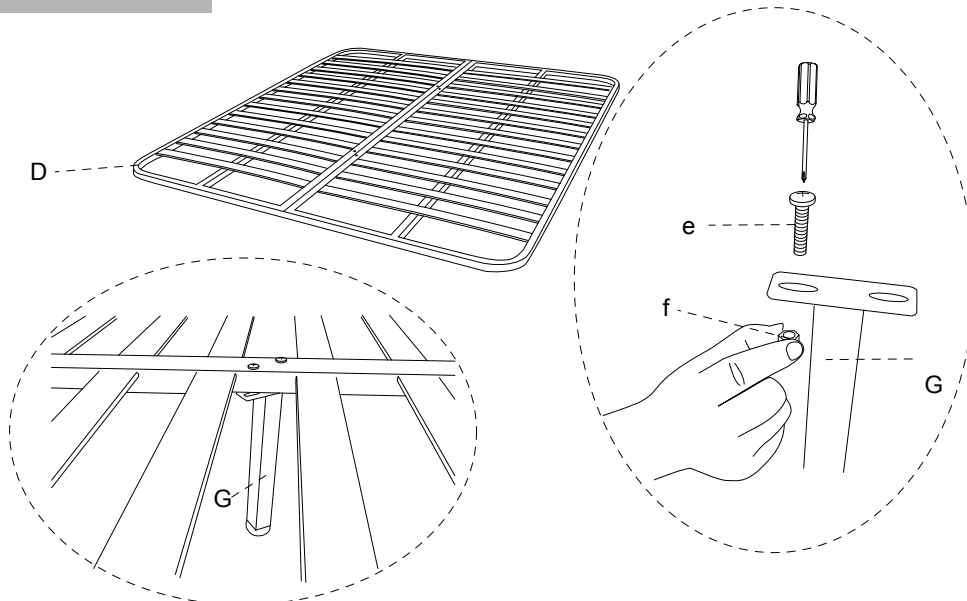

STEP 4

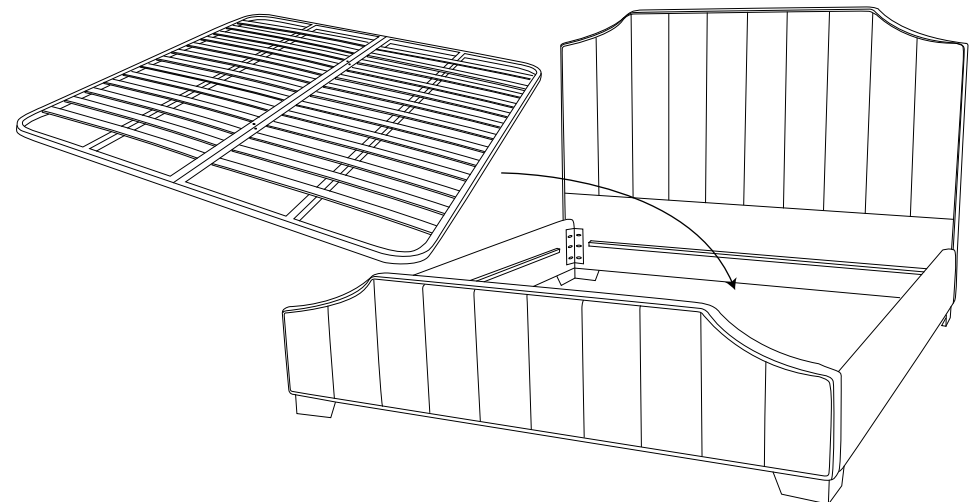

A SCREWDRIVER IS REQUIRED TO ASSEMBLE THE LEGS.