

BACK DRAFT DAMPER

ROUND DAMPER TO PREVENT RETURN-AIR FROM ENTERING KITCHEN

MODEL	DUCT		DIMENSIONS			
	SIZE	A	B	C	D	E
AK00029	6"	6"	6"	2-7/8"	2-7/8"	1/4"
AK00049	7"	7"	7"	3-1/4"	3-1/4"	1/2"
AK00069	8"	8"	8"	3-5/8"	3-5/8"	3/4"



FEATURES

- Vertical Duct Application
- Galvanized (G-90)
- Foam Seal for Damper Closure
- NOT FOR USE WITH DRYER VENT APPLICATIONS

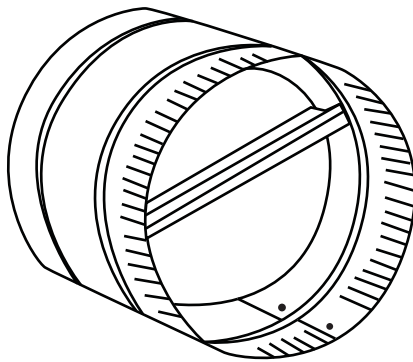

3/4 View

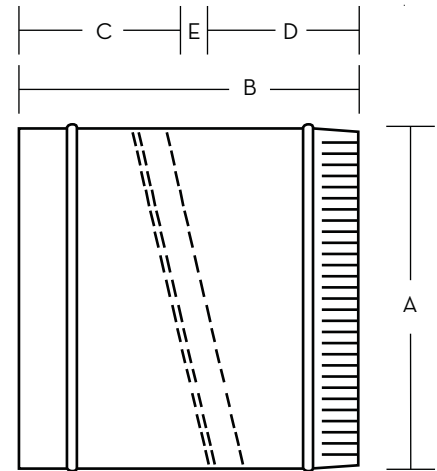

Side View

TAPERED REDUCER

REDUCES ROUND DUCT SIZE

MODEL	DUCT		DIMENSIONS	
	SIZE	A	B	C
AK00039	7x6"	1-3/4"	1-3/4"	5"
AK00037	8x6"	1-3/4"	1-3/4"	4-3/4"
AK00035	8x7"	1-3/4"	1-3/4"	4-1/4"
AK00040	10x8"	1-3/4"	1-3/4"	5"

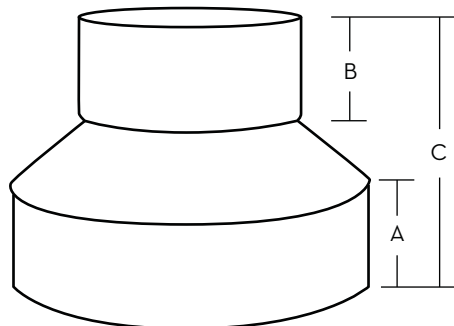

Side View



FEATURES

- Tapered for Best Air Flow
- Galvanized (G-90)

ROOF CAP EXHAUST, J-VENT

EXHAUST CAP FOR ROUND DUCTING, INSTALLS ON ROOF

MODEL	DUCT SIZE			DIMENSIONS						
	A	B	C	D	E	F	G	H	I	
AK00046	6"	12"	6"	3"	15"	10"	5-1/8"	3-1/4"	1-7/8"	3-1/4"
AK00047	7"	12"	7"	2-1/2"	15"	11"	5-1/8"	3-1/4"	1-7/8"	3-1/4"
AK00048	8"	15"	8"	3-1/2"	15"	12"	5-1/2"	3-1/2"	2"	3-1/4"
AK00050	10"	15"	10"	2-1/2"	20"	16"	6-1/2"	4-1/4"	2-1/4"	3-1/2"



FEATURES

- Low Profile
- Install of Any Roof Pitch
- Mesh Bird Screen
- Galvanized (G-90)

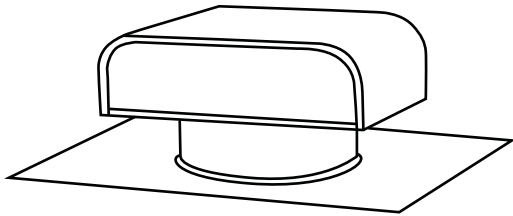

3/4 View

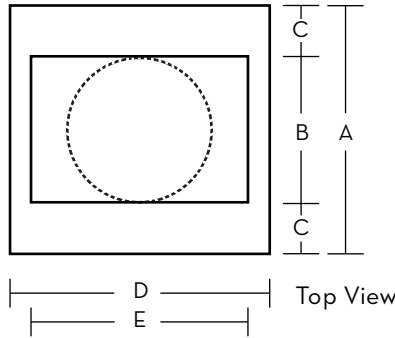

Top View

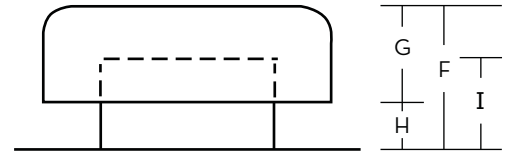

Side View

WALL CAP EXHAUST, 3-1/4"x10" RECTANGULAR

EXHAUST CAP FOR RECTANGULAR DUCTING, PREVENTS RETURN-AIR, INSTALLS ON EXTERIOR WALL

MODEL	DIMENSIONS						
	A	B	C	D	E	F	G
AK00041	3-1/4"	10"	5-5/8"	11"	5"	12-3/4"	9-1/2"



FEATURES

- Aluminum Damper Included
- Mesh Bird Screen
- Rain Proof
- Galvanized (G-90)
- NOT FOR USE WITH INLET VENT APPLICATIONS

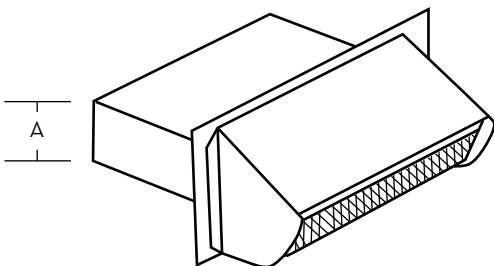

3/4 View

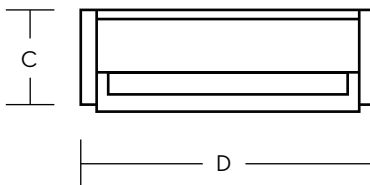

Front View

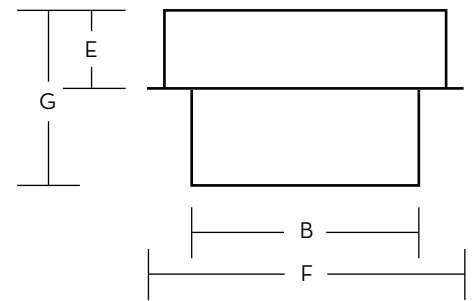

Top View

WALL CAP EXHAUST, ROUND

EXHAUST CAP FOR ROUND DUCTING, PREVENTS RETURN-AIR, INSTALLS ON EXTERIOR WALL

MODEL	DUCT			DIMENSIONS					
	SIZE	A	B	C	D	E	F	G	H
AK00042	6"	6"	7-5/8"	8"	1"	8-1/2"	9"	8-5/8"	7-1/8"
AK00043	7"	7"	8-5/8"	9-5/8"	1"	8-1/2"	10-3/4"	9-5/8"	8-1/8"
AK00044	8"	8"	10"	11-5/8"	1-3/4"	8-1/2"	10-3/8"	11-1/8"	10-3/8"
AK00045	10"	10"	12"	13"	1-3/4"	8-1/2"	11-1/2"	13-5/8"	13-7/8"



FEATURES

- Aluminum Damper Included
- Rain Proof
- Mesh Bird Screen
- Galvanized (G-90)

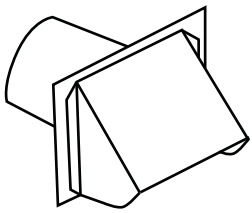

3/4 View

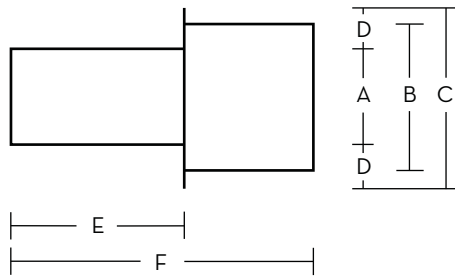

Top View

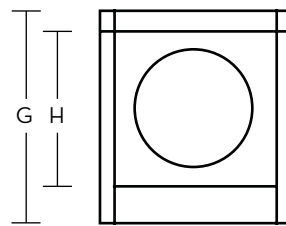
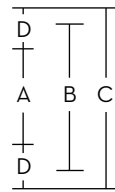

Back View

WALL CAP INLET, ROUND

FRESH AIR INLET FOR ROUND DUCTING, COMMONLY USED WITH MAKE-UP AIR KITS

MODEL	DUCT			DIMENSIONS					
	SIZE	A	B	C	D	E	F	G	H
AK00030	6"	6"	7-5/8"	8"	1"	8-1/2"	9"	8-5/8"	7-1/8"
AK00031	7"	7"	8-5/8"	9-5/8"	1"	8-1/2"	10-3/4"	9-5/8"	8-1/8"
AK00032	8"	8"	10"	11-5/8"	1-3/4"	8-1/2"	10-3/8"	11-1/8"	10-3/8"



FEATURES

- Mesh Bird Screen
- Galvanized (G-90)
- Rain Proof

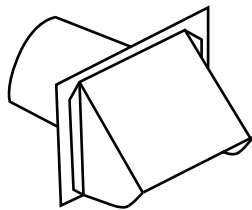

3/4 View

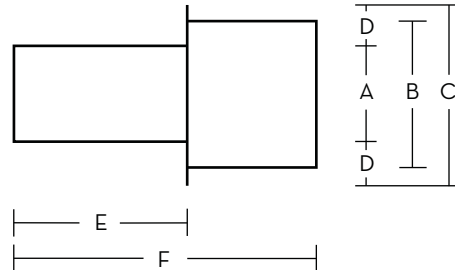

Top View

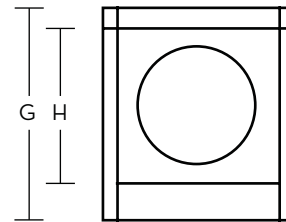
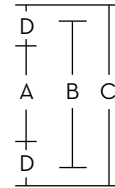

Back View