

CARE AND MAINTENANCE

Store outdoor furniture indoors or cover well when not in use.

Remove wooden furniture from standing water. Dust regularly with small brush or vacuum

Spills should be taken care of immediately before they harden or stain with a slightly dampened sponge.

NOTICE









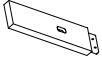
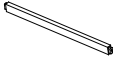

* Please make sure that you have all parts indicated before you begin assembly of this item

* This item should be assembled on a soft surface to prevent scratching the finish during assembly

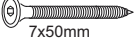
* This item may require periodic tightening

 **SAFAVIEH**
O U T D O O R

Part List and Hardware List

PIECE	DESCRIPTION	PICTURE	QUANTITY
A	Sunlouger frame		1X
B	Front leg		2X
C	Cross bar of leg		2X
D	Wheel		2X
E	Block conner		8X
H1	Back leg		2X
H2	Screw -1	 7x50mm	4X
H3	Screw - 2	 6 x 20mm	8X
H4	Allen bolt	 8x50mm	2X
H5	Washer		2X
H6	Screw -3	 6 x 60mm	16X
H7	Allen key		2X
H8	Allen key		1X

Model# PAT7022

Product Dimensions:25.19" W x 34.25" D x 34.25" H



PREPARATION

Before beginning assembly of product, make sure all parts are present. Compare parts with package contents list and hardware contents list. If any part is missing or damaged, do not attempt to assemble the product.

Estimated Assembly Time: 30 minutes.

Tools Required for Assembly (included): Allen Key

1

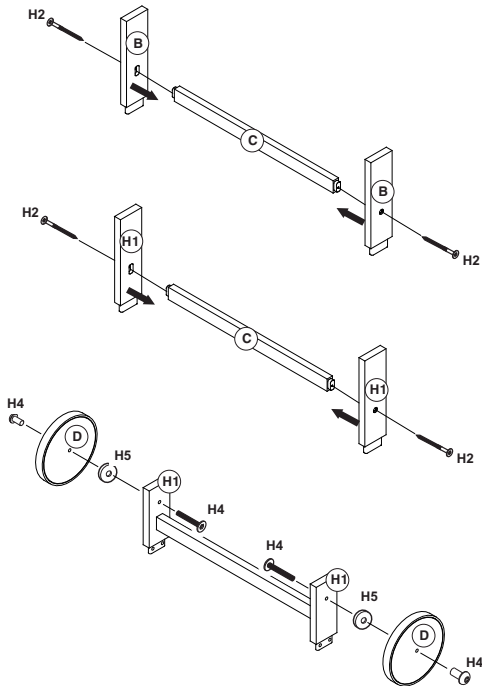

2

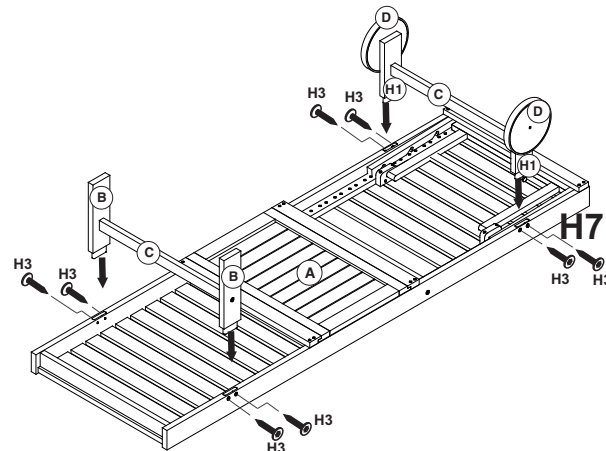

3

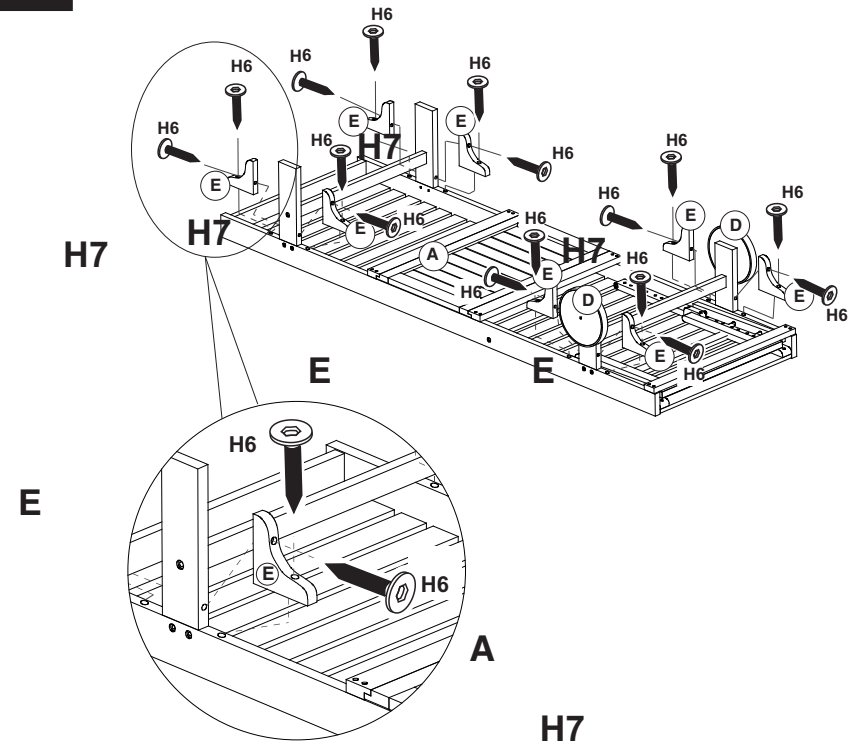

Step 1

- Attached (B) & (C),using H2 tighten with H8
- Attached (H1)& (C),using H2 tighten with H8
- Attached (D) & (H1) insert (H3) inside using (H4) tighten with (H7)

Step 2

- (B) & (C) attached to (A),using (H3) tighten with(H8),(D),(H1),(C),attached to (A),using (H3) tighten with (H8)

Step 3

- Attached (E) & (B),using (H6) tighten with H8.
- Attached block (H1),using (H6) tighten with (H8).