

Model No: C1C28-FS



Features:

- Two high performance Coyote Infinity Burners™
- 640 sq. in. cooking area
- Up to 40,000 BTU
- Complete 304 stainless steel construction
- Interior grill lighting
- Integrated wind guard
- Slide out tray for 20lb propane tank

Dimensions:

- With Shelves Up: (H) 50" x (W) 56 1/2" x (D) 25 1/2"
- With Shelves Down: (H) 50" x (W) 34" x (D) 25 1/2"

Accessories:

- Laser-Cut Signature Grates (CSIGRATE15)
- Charcoal trays (CCHTRAY15)
- 14" stainless steel griddle (C1GRDL)
- Custom fit, weather resistant cover
- Gas conversion kit

C1C28 PRODUCT SPECS

DIMENSIONAL RENDERINGS

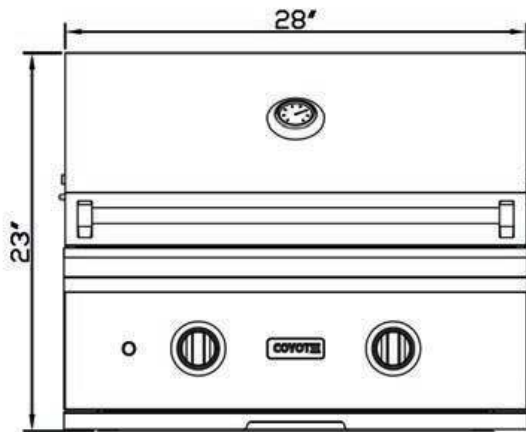

FRONT VIEW

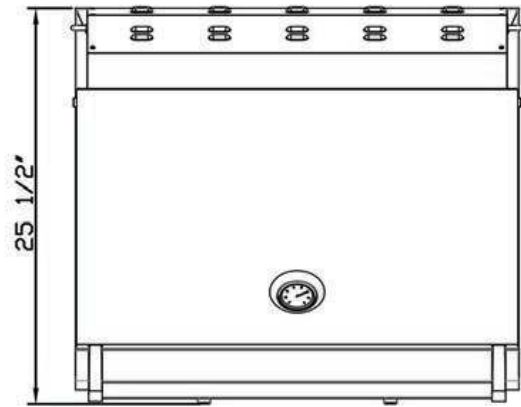

TOP VIEW

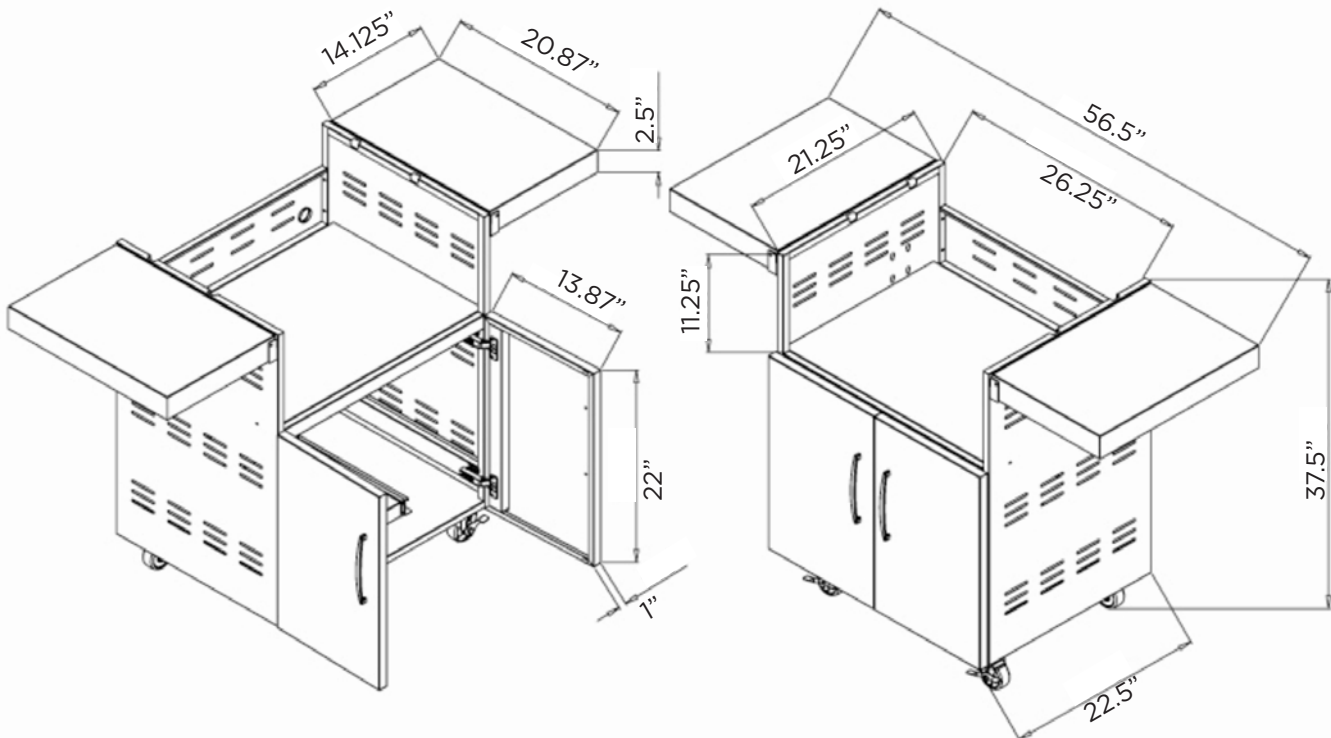

COYOTE

Outdoor Living

www.coyoteoutdoor.com