BERTAZZONI PROFESSIONAL SERIES

36" UNDERMOUNT CANOPY HOOD

KU36 PRO 1 XV

HIGHLIGHTS

- Double motor canopy hood features a narrow or full-width duct cover as optional.
- 400 CFM max extraction power with one motor controlled by 3 speed settings.
- 2 LED lights give exceptionally bright worktop illumination.

FEATURES

Hood finishing	stainless steel
Motor	1
Speed	3
Hood control	slider
LED lights	2
Filters	aluminum mesh
Max extraction power	400 CFM

TECHNICAL SPECIFICATIONS

Voltage, frequency	120 V 60 Hz
Max Amp usage, power rating	3.3 A - 400 W
Certification	CSA
Warranty	2 years parts and labor

ACCESSORIES

Narrow duct cover	code 901262
Medium duct cover	code 901263
Full-width duct cover	code 901265
Narrow duct cover for ceiling height 8-10 ft	code 901281
Kit Aluminum mesh filters	code 901402
Recirculation Kit	code 901336

All KU hoods can be installed under 12" deep wall cabinets or with the optional height-adjustable medium- and full-width duct covers.



INSTALLATION INSTRUCTIONS

KU36 PRO 1 XV

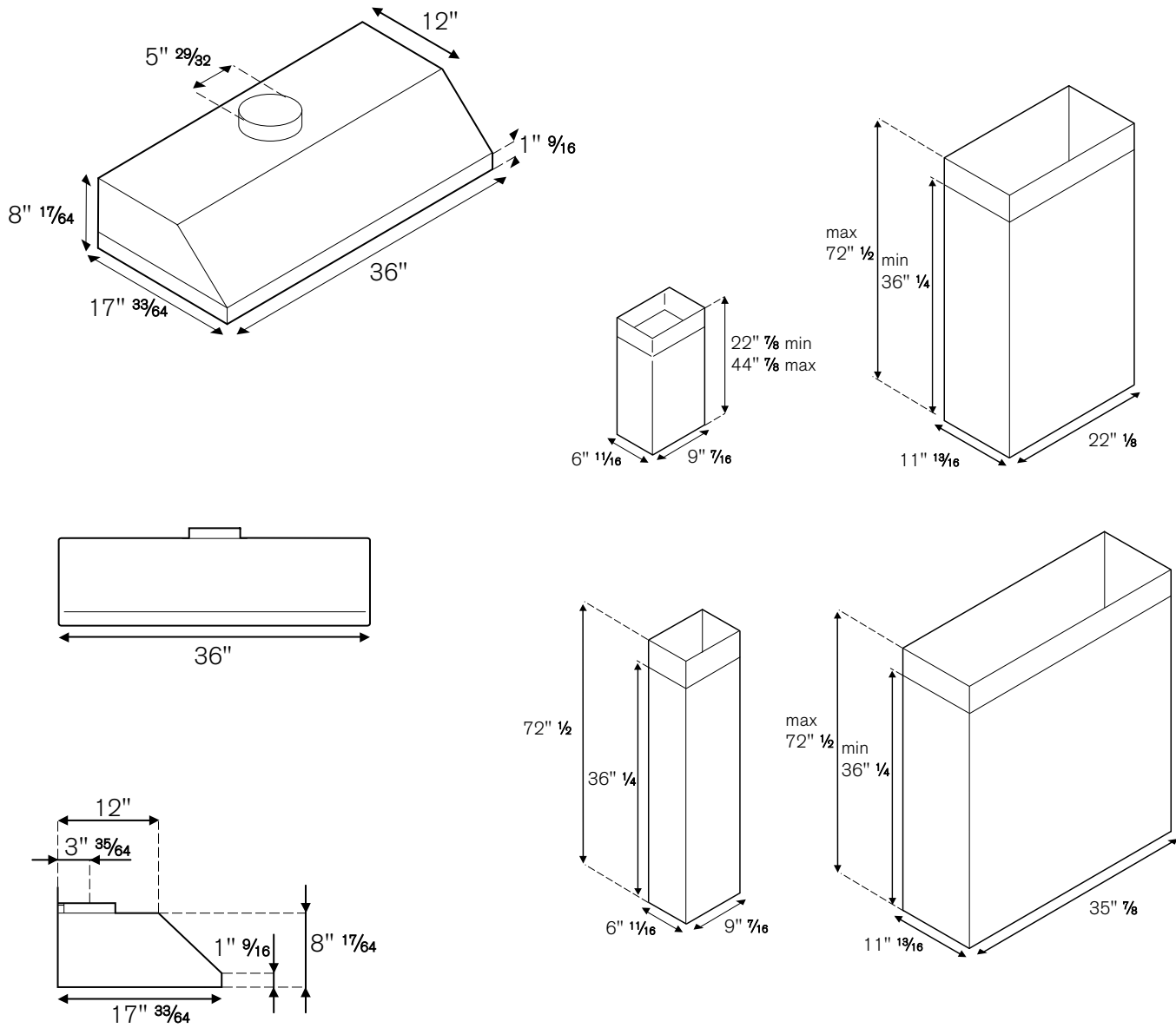

Bertazzoni recommends to operate the appliance after it has been properly installed. Please refer to the installation manual for further details.

Disclaimer: while every effort has been made to insure the accuracy of the information contained in this brochure, Fratelli Bertazzoni reserves the right to change any part of the information at any time without notice.

Fratelli Bertazzoni, Bertazzoni and the winged wheel brand icon are registered trademarks of Bertazzoni Spa.