

DLEX7900*E / DLGX7901*E

7.3 cu.ft. Rear Control Dryer with TurboSteam™

7.3 cu. ft. Ultra Large Capacity
 TurboSteam™ Technology
 EasyLoad™ Door
 ThinQ® Technology with Proactive Customer Care
 Sensor Dry
 FlowSense™ Duct Clogging & Lint Filter Indicators
 ENERGY STAR® Certified
 Aluminized Alloy Steel Drum
 LoDecibel™ Quiet Operation

AVAILABLE COLORS



BLACK STEEL



WHITE



Enjoy new ways to control your home with LG smart appliances

- Use the ThinQ® app to start the laundry while you're out
- Get alerts when the cycle is finished
- Proactive Customer Care offers preventative maintenance tips

LG ThinQ®



SUMMARY		FABRIC CARE FEATURES		POWER SOURCE	
Type	Rear Control Top Load Dryer	Sensor Dry	Yes	Ratings	CSA Listed
Capacity	7.3 cu ft	Precise Temperature Control with Variable Heater	Yes	Electrical Requirements	Electric: 240V 30 Amps Gas: 120V, 15 Amps
Matching Washer	WT7900HBA / WT7900HWA	Steam	Yes	Type	Electric or Gas
Sensor Dry	Yes	CONVENIENCE FEATURES		BTU	Gas: 20,000
Steam	Yes	3 Minute Installation Check	Yes	OPTIONS	
Color	Black Steel (B) / White (W)	LoDecibel™ Quiet Operation	Yes	LP Conversion Kit	383EEL3002D / LPK1
APPEARANCE		End of Cycle Signal	Yes	Side Venting Kit	383EEL9001B
EasyLoad™ Door	Yes	Drum Light	Yes	DIMENSIONS	
Intelligent Electronic Controls with LED Display	Yes	Reversible Door	Yes	Product (WxHxD)	27" x 44 1/4" x 29 1/2"
Dial-A-Cycle™	Yes	FlowSense™ Duct Clogging Indicator	Yes	Depth with Door Open	50 1/4"
DRYER PROGRAMS		Wrinkle Care Option	Yes	Carton (WxHxD)	29 1/2" x 47 1/8" x 30 7/8"
No. of Programs	14	Child Lock	Yes	Weight (Product)	Electric: 124.8 Gas: 129.8
	Normal, Heavy Duty, Bedding, Small Load, Anti Bacterial, SteamSanitary™, SteamFresh™, Perm Press, Delicates, Sportswear, Towels, Speed Dry (Manual Dry), Air Dry (Manual Dry), Downloaded	Venting Option	Electric: 4 Way Venting Gas: 3 Way Venting	Weight Carton	Electric: 144.6 Gas: 149.6
DRYER OPTIONS		4 Adjustable Legs	Yes	LIMITED WARRANTY	
No. of Options	12	Remaining Time Display/Status Indicator(s)	Yes	Parts & Labor	1 Year
	More Time, Less Time, Damp Dry Signal, Wrinkle Care, Control Lock, Wi-Fi, Energy Saver, TurboSteam™, Reduce Static, Remote Start, Drum Light, Signal	SMART FEATURES		UPC CODES	
DRYER DETAILS		LG ThinQ® Technology	Yes	DLEX7900BE (Black Steel Electric Dryer)	048231015486
Temperature Settings	High, Med.High, Medium, Low, Ultra Low	Proactive Customer Care (PCC)	Yes	DLGX7901BE (Black Steel Gas Dryer)	048231015509
Drying Levels	Very Dry, More Dry, Normal Dry, Less Dry, Damp Dry	SmartDiagnosis™	Yes	WT7900HBA (Black Steel Washer)	048231015462
Manual Dry Times	60 min., 50 min., 40 min., 30 min., 20 min., More Time/Less Time	WiFi Connectivity	Yes	DLEX7900WE (White Electric Dryer)	195174026717
		Energy Monitoring	Yes (WiFi)	DLGX7901WE (White Gas Dryer)	195174026724
		Remote Start and Cycle Monitor	Yes	WT7900HWA (White Washer)	195174026618
		ENERGY			
		ENERGY STAR® Qualified	Yes		
		MATERIALS AND FINISHES			
		Aluminized Alloy Steel Drum	Yes		
		Tub Rear	Painted		
		Cabinet	Painted Steel		

DLEX7900*E / DLGX7901*E

7.3 cu.ft. Rear Control Dryer with TurboSteam™

QUICK INSTALL & CLEARANCES

For full installation directions/clearances please refer to the corresponding User Manual and Installation Guide.

DIMENSIONS/CLEARANCES/WEIGHTS

A Width	27"
B Height	44 1/4"
C Depth	29 1/2"
D Depth with Door Open (in)	50 1/4"
Carton Dimensions (WxHxD)	29 1/2" x 47 1/8" x 30 7/8"
ENERGY / RATINGS	
ENERGY STAR® Qualified	Yes
Ratings	CSA Listed
Electrical Requirements / Type	Electric: 240V 30 Amps Gas: 120V, 15 Amps
BTU	20,000 Feet

DIMENSIONS AND CLEARANCES

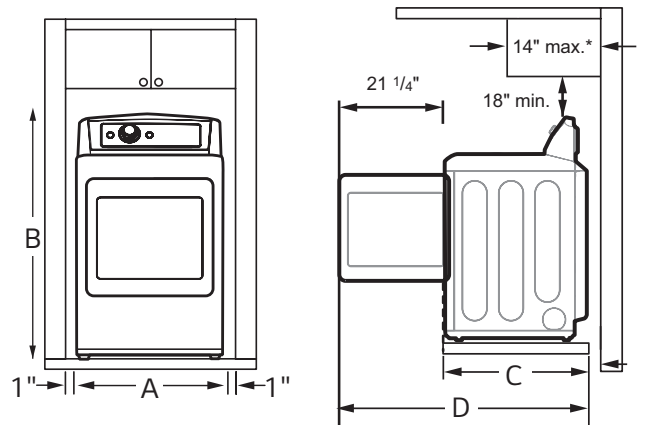

- Install the washing machine on a solid floor that is strong and rigid enough to support the weight of the washing machine, even when fully loaded, without flexing or bouncing. If the floor has too much flex, you may need to reinforce it to make it more rigid. If the floor is not solid, it may cause severe vibration and noise.

CONNECTING THE GAS SUPPLY

- Installation and service must be performed by a qualified installer, service agency, or the gas supplier.
- Use only a new stainless steel flexible connector and a new AGA-certified connector.
- A gas shutoff valve must be installed within 6 ft. (1.8 m) of the dryer.
- The dryer is configured for natural gas when shipped from the factory. Make sure that the dryer is equipped with the correct burner nozzle for the type of gas being used (natural gas or propane gas).
- If necessary, the correct nozzle (for the LP nozzle kit, order part number 383EEL3002D) should be installed by a qualified technician and the change should be noted on the dryer.
- All connections must be in accordance with local codes and regulations. Gas dryers MUST exhaust to the outdoors.

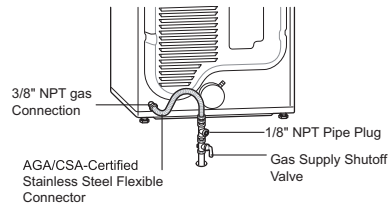

VENTING / DUCTWORK

NOTE: Follow the guidelines below to maximize drying performance and reduce lint buildup and condensation in the ductwork. Ductwork and fittings are NOT included and must be purchased separately.

- Use 4-inch (10.2 cm) diameter rigid, semi-rigid or flexible metal ductwork.
- The exhaust duct run should be as short as possible.
- Use as few elbow joints as possible.
- The male end of each section of exhaust duct must point away from the dryer.
- Use duct tape on all duct joints.
- Insulate ductwork that runs through unheated areas in order to reduce condensation and lint buildup on duct surfaces.
- Incorrect or inadequate exhaust systems are not covered by the dryer warranty. Dryer failures or service required because of such exhaust systems will not be covered by the dryer warranty.

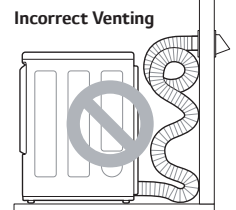
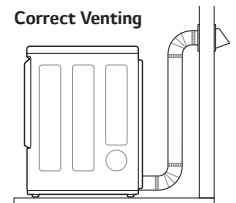





CONNECTING ELECTRIC DRYERS

- A **4-wire connection** is required for all mobile and manufactured home installations, as well as all new construction **after January 1, 1996**.
- A **3-wire connection is NOT permitted** on new construction **after January 1, 1996**.
- A UL-listed strain relief is required.
- Use a 30-amp, 240-volt, 4-wire, UL-listed power cord with #10 AWG-minimum copper conductor and closed loop or forked terminals with upturned ends.



- Ductwork is not provided with the dryer. You should obtain the necessary ductwork locally. The vent hood should have hinged dampers to prevent backdraft when the dryer is not in use.
- The total length of flexible metal duct must not exceed 8 ft. (2.4 m).
- Deduct 6 ft. (1.8 m) for each additional elbow. Do not use more than four 90° elbows.

Wall Cap Type	Number of 90° Elbows	Maximum length of 4-inch diameter rigid metal duct	
 Recommended	0	65 ft.(19.8 m)	
	1	55 ft.(16.8 m)	
	2	47 ft.(14.3 m)	
	3	36 ft.(11.0 m)	
 a: 4" (10.2 cm)	4	28 ft.(8.5 m)	
	 Use only for short run installations	0	55 ft.(16.8 m)
		1	47 ft.(14.3 m)
		2	41 ft.(12.5 m)
3		30 ft.(9.1 m)	
 b: 2.5" (6.35 cm)	4	22 ft.(6.7 m)	