

CVA 7445

Built-in coffee machine with DirectWater

In a perfectly combinable design with patented CupSensor for perfect coffee.



- Large clear text display with sensor controls – DirectSensor
- Perfectly positioned: thanks to the patented CupSensor
- 2 coffees at once at the touch of a button – OneTouch for Two
- Always freshly ground – AromaticSystemFresh
- Convenient when hosting lots of guests – coffee/tea pot function

EAN: 4002516426646 / Material number: 11754300 / Old Material Number: 29744540USA

Construction type and design	
Built-in bean-to-cup coffee machine	•
PureLine	•
Color	Clean Touch Steel
Consumer benefits	
AromaticSystemFresh	•
OneTouch preparation	•
One Touch and OneTouch for Two	•
DoubleShot	•
Programmable User profile	10
Flavor preserving conical grinding unit	•
Grinding grade selectable	•
Ground quantity programmable	•
Water quantity programmable	•
Water temperature programmable	•
Amount of milk can be programmed	•
Amount of milk froth can be programmed	•
Pre-brewing programmable	•
TeaTimer	•
Control panel	
Networking with Miele@home	•
Control panel	DirectSensor
CupSensor	•
Height adjustment of infinitely adjustable central spout min in in.(cm)	1 5/8 (4.0)
Height adjustment of infinitely adjustable central spout max in in.(cm)	6 1/2 (16.5)
PerformanceMode	•
EasyClick milk container	•
ComfortDoor	•
Hidden door handle	•
BrilliantLight	•
Expert mode	•
Multilingua	•
No. of bean types	1
No. of bean containers	2
Bean container capacity, each in oz (g)	300
Capacity of bean container B in g	300
Bean container capacity, total in oz (g)	21.16 (600)
Removable bean container	•
Capacity of water container in fl oz (l)	91.3 (2.7)
Milk container capacity in l	0.7
Drip tray capacity in fl oz (l)	54.1 (1.6)
Easily accessible containers	•
Time-of-day display	•
Time synchronization	•
Date display	•
Programmable switch-on time	•
Programmable switch-off time	•
Programmable stand-by time	•

CVA 7445

Built-in coffee machine with DirectWater

In a perfectly combinable design with patented CupSensor for perfect coffee.



EAN: 4002516426646 / Material number: 11754300 / Old Material Number: 29744540USA

Individual settings	•
Beverages	
Adjustable beverage portion size in ml	20-300
Ristretto, single	•
Ristretto, double	•
Espresso, single	•
Espresso, double	•
Coffee, single	•
Coffee, double	•
Long coffee, single	•
Long coffee, double	•
Cappuccino, single	•
Cappuccino, double	•
Latte macchiato, single	•
Latte macchiato, double	•
Hot milk, single	•
Latte macchiato, double	•
Milk froth, single	•
Milk froth, double	•
Espresso macchiato, single	•
Espresso macchiato, double	•
Cappuccino italiano, single	•
Cappuccino italiano, double	•
Flat white, single	•
Flat white, double	•
Café au lait, single	•
Café au lait, double	•
Caffè latte, single	•
Caffè latte, double	•
Caffè americano, single	•
Caffè Americano, double	•
Long black, single	•
Long black, double	•
Allwater	•
Warm water, double	•
Hot water, single	•
Hot water, double	•
Black tea, single	•
Black tea, double	•
Herbal tea, single	•
Herbal tea, double	•
Fruit tea, single	•
Fruit tea, double	•
Green tea, single	•
Green tea, double	•
White tea, single	•
White tea, double	•
Japanese tea, single	•
Japanese tea, double	•
Chai latte, single	•
Chai latte, double	•

CVA 7445

Built-in coffee machine with DirectWater

In a perfectly combinable design with patented CupSensor for perfect coffee.

EAN: 4002516426646 / Material number: 11754300 / Old Material Number: 29744540USA

Coffee pot	•
Teapot	•
Efficiency and sustainability	
Energy-saving Eco mode option	•
Power rating in standby mode in W	0.6
Power rating in networked standby in W	0.9
Time until automatic switch to off mode in min	20
Time until automatic switch to standby in min	20
Time until automatic switch to networked standby in min	20
Cleaning convenience	
Stainless steel front with Clean Touch Steel surface	•
Manual descaling	•
Automatic rinsing of the milk pipework from the water container	•
Convenient cleaning programs	•
Auto-Off function	•
ComfortClean	•
Removable milk pipework	•
Removable brew unit	•
Adjustable water hardness	•
Safety	
System lock	•
Technical data	
Niche width min in in.(mm)	22 1/8 (560)
Niche width max in in.(mm)	22 3/8 (568)
Niche height min in in.(mm)	17 3/4 (450)
Niche height max in in.(mm)	17 7/8 (452)
Niche depth in in.(mm)	21 3/4 (550)
Appliance width in in.(mm)	23 1/2 (595)
Appliance height in in.(mm)	18 (455)
Appliance depth in in.(mm)	18 7/8 (478)
Depth with door open in in.(cm)	42 5/8 (108.0)
Total connected load in kW	1.45
Voltage in V	120
Fuse rating in A	15
Number of phases	1
Length of electrical wire in ft (m)	6 (2.0)
Accessories supplied	
Glass milk container	•
Descaling tablets	•
Cleaning tablets	•
Milk pipework cleaner	•
Miele coffee 250 gr	•

CVA 7445

Built-in coffee machine with DirectWater

In a perfectly combinable design with patented CupSensor for perfect coffee.



EAN: 4002516426646 / Material number: 11754300 / Old Material Number: 29744540USA

Available display languages

Available display languages via MultiLingua

bahasa malaysia, dansk,
deutsch, eesti, english,
english (AU), english (CA),
english (GB), english (US),
español, français, français
(CA), français (FR), hrvatski,
italiano, latviesu, lietuviu,
magyar, nederlands,
norsk, polski, português,
русский, română,
slovenčina, slovenščina,
srpski, suomi, svenska,
türkçe, українська, čeština,
ελληνικά,

CVA 7445

Built-in coffee machine with DirectWater

In a perfectly combinable design with patented CupSensor for perfect coffee.

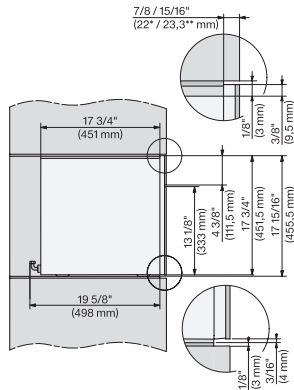

CVA7445, CVA7845, installation drawing, side view, 60 cm, Flush inset, NA

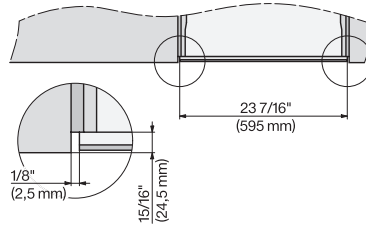

CVA7440, CVA7445, CVA7840, CVA7845, installation drawing, view from above, 60 cm, Flush inset

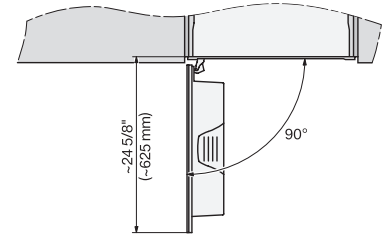

CVA7440, CVA7445, CVA7840, CVA7845, installation drawing, view from above, 60 cm, Flush inset

7/8" – 22" mm – Glass, 15/16" – 23.3" mm – Stainless steel

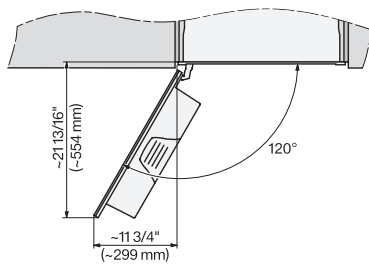

CVA7440, CVA7445, CVA7840, CVA7845, installation drawing, view from above, 60 cm, Flush inset

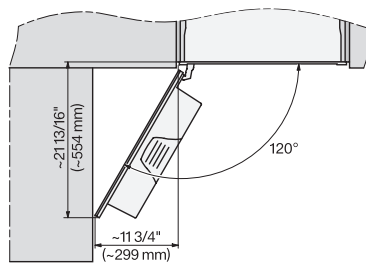

CVA7440, CVA7445, CVA7840, CVA7845, installation drawing, view from above, 60 cm, Flush inset

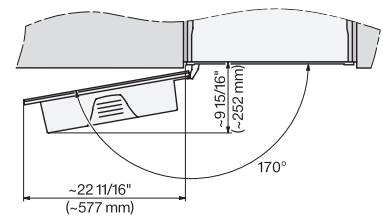

CVA7440, CVA7445, CVA7840, CVA7845, installation drawing, view from above, 60 cm, Flush inset

CVA 7445

Built-in coffee machine with DirectWater

In a perfectly combinable design with patented CupSensor for perfect coffee.

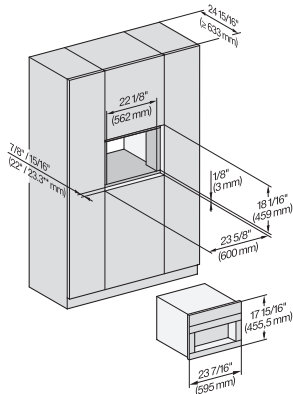

CVA7440, CVA7745, CVA7840, CVA7845, installation drawing, built in, 60 cm, Flush inset

7/8" – 22" mm – Glass, 15/16" – 23.3** mm – Stainless steel

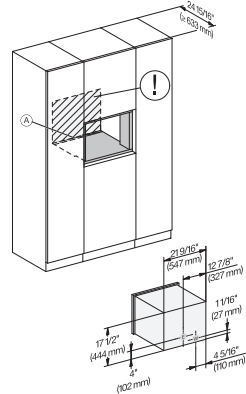

CVA7445, CVA7845, installation drawing, installation, 60 cm, Flush inset

A – Cut-out (1 1/2" x 20" / 38 mm x 508 mm) in the bottom of the cabinet for power cord and ventilation, – Electrical and water supplies are recommended to be placed in adjacent cabinetry., Additional cabinet depth is required when placing the electrical and water supplies behind the appliance., E = Electric connection, W = Water connection

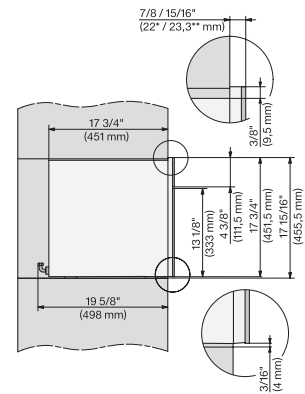

CVA7445, CVA7845, side view, 60 cm, Proud

7/8" – 22" mm – Glass, 15/16" – 23.3** mm – Stainless steel

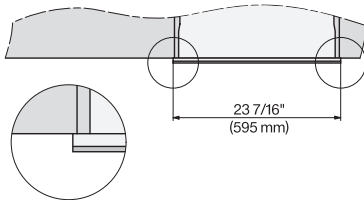

CVA7440, CVA7445, CVA7840, CVA7845, installation drawing, view from above, 60 cm, Proud

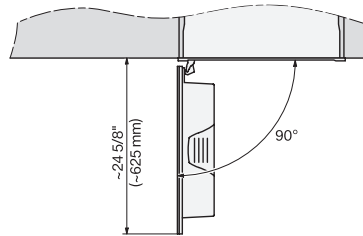

CVA7440, CVA7445, CVA7840, CVA7845, installation drawing, view from above, 60 cm, Proud

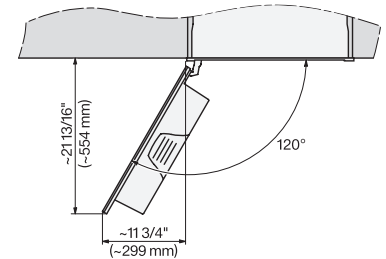

CVA7440, CVA7445, CVA7840, CVA7845, installation drawing, view from above, 60 cm, Proud

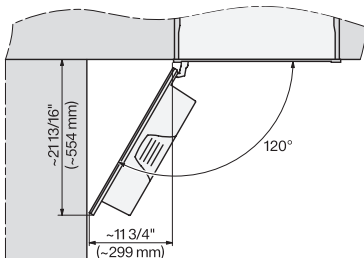

CVA7440, CVA7445, CVA7840, CVA7845, installation drawing, view from above, 60 cm, Proud

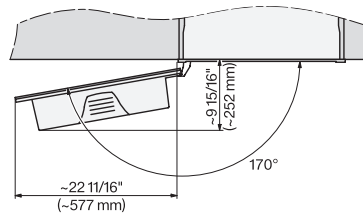

CVA7440, CVA7445, CVA7840, CVA7845, installation drawing, view from above, 60 cm, Proud

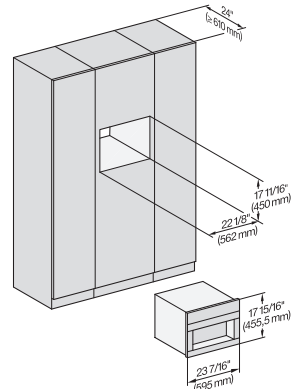

CVA7440, CVA7445, CVA7840, CVA7845, installation drawing, built in, Einbau, 60 cm, Proud

CVA 7445

Built-in coffee machine with DirectWater

In a perfectly combinable design with patented CupSensor for perfect coffee.

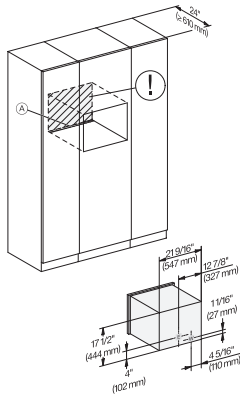

CVA7445, CVA7845, installation drawing, installation,
60 cm, Proud

A – Cut-out (1 1/2" x 20" / 38 mm x 508 mm) in the bottom of the cabinet for power cord and ventilation. – Electrical and water supplies are recommended to be placed in adjacent cabinetry. Additional cabinet depth is required when placing the electrical and water supplies behind the appliance. E = Electric connection, W = Water connection