



**TWIN EAGLES, INC.**

*Defining the Art of Outdoor Cooking*

**TWIN EAGLES ALL WEATHER  
ELECTRIC RADIANT HEATER  
OWNER'S MANUAL**



MODEL    TEEH-1512  
            TEEH-2524  
            TEEH-3524

**NEED ASSISTANCE? PLEASE CALL:  
(562) 802-3488**

This heater must be permanently installed and hard wired by a licensed contractor.

TWIN EAGLES, INC.  
13231 East 166<sup>th</sup> St.  
Cerritos, CA 90703  
1(562) 802-3488  
[www.twineaglesbbq.com](http://www.twineaglesbbq.com)



# TABLE OF CONTENTS – ELECTRIC HEATER

## IMPORTANT INFORMATION

|                                   |     |
|-----------------------------------|-----|
| Assembly Instructions.....        | 2   |
| Mounting Suggested Locations..... | 3   |
| Mounting Instructions.....        | 4   |
| Wiring Instructions.....          | 5-6 |

**NOTE: DO NOT** mount the heater on a vertical axis. Such installation will reduce the life of the element and will automatically **VOID** the product’s warranty. For maximum element life, use a level to find the **Horizontal Axis** position of the heater body. Heater must be leveled but can be swiveled on its horizontal axis.

|                                     |          |
|-------------------------------------|----------|
| <b>REPLACEMENT PARTS LIST</b> ..... | 7        |
| <b>TROUBLESHOOTING GUIDE</b> .....  | 8        |
| <b>WARRANTY</b> .....               | 9        |
| <b>WARRANTY REGISTRATION</b> .....  | Appendix |

### **WARNING**

Never block the front grill of the heater.  
The heater is not suitable for hazardous locations.  
This unit may be a source of possible shock and ignition.  
Do NOT operate within 25 feet of flammable material.  
NEVER attempt to service the heater without disconnecting its power source.

SAVE THIS MANUAL FOR FUTURE REFERENCE



# ASSEMBLY INSTRUCTIONS – ELECTRIC HEATER

**NOTE:**

- a) The heater must be permanently installed and hard wired by a licensed contractor.
  - b) Twin Eagles electric heater is shipped with the heating element uninstalled to prevent it from breaking from any possible shipping impact.
  - c) Assembly procedure must be performed with no electrical power to the unit.
- 1) When you open the box, all components should be organized as seen on the picture. Remove the box with the element and place it in a safe area, you will need it later on. Remove the rest of the cardboard inserts including the mounting brackets on each side. Then take the heater out of the box and place it on a flat surface.

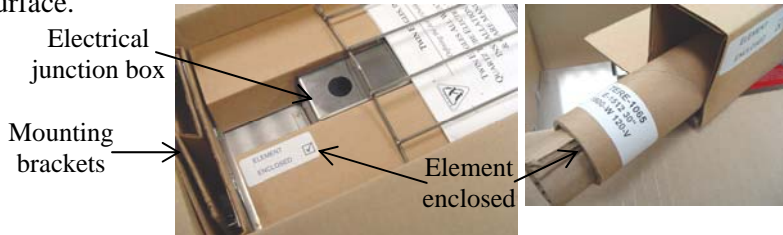

- 2) Look at the rear area of the heater unit and reference the UL label for the electrical requirements. The electrical requirements should either be;

- i. 120V (1500W) (TEEH-1512)
- ii. 240V (2500W) (TEEH-2524)
- iii. 240V (3500W) (TEEH-3524)

**A)** Once electrical requirements on the heater have been identified, compare it versus the elements electrical rating they're to be the same. If the two electrical requirements are not the same, contact the customer service department. If they are the same, continue by removing the end-plates on each side.

**B)** Open the hold-down-clip on both sides and CAREFULLY install the heating element (no polarity) and remove the outer nut ( $1\frac{1}{32}$ " ) and insert the round wire terminal into the element end. Place the outer nut back in and tighten the outer nut while holding the inner nut with a second wrench. Be careful not to damage the element's ceramic ends during this process. If connection is left loose it could cause element to fail. Then bring down the hold-down-clips on both sides. With the use of a cloth, wipe the element and reflector to eliminate any finger prints or debris.

**C)** Install the *front grill safety cover* by pushing the legs into the seam as seen on picture "C".

**D)** Screw the end plates back on and remove the protective blue plastic.

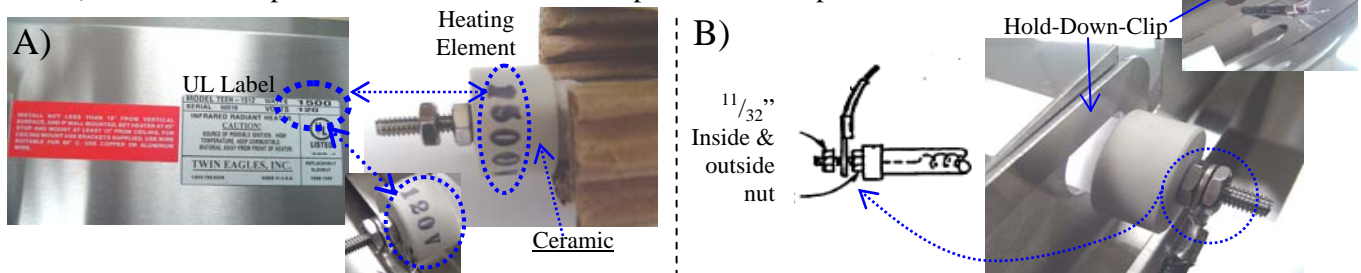

**C) Front Grill Safety Cover**

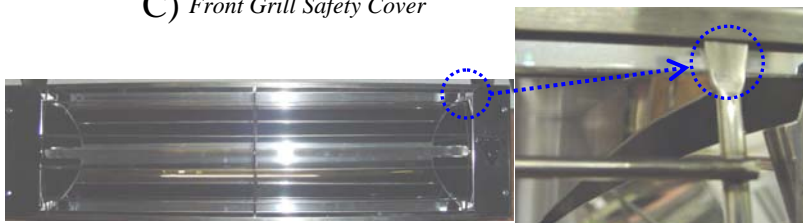

**D) End Plates**



## MOUNTING SUGGESTED LOCATIONS – ELECTRIC HEATER

Unless heaters are installed over 12 ft. high, it is generally recommended that radiant heaters be mounted on an angle to assure that radiant warmth is distributed from the sides rather than straight down on the heads and shoulders of people being warmed.



When outdoors, hang heaters under protective roof or weather cover whenever possible. Even though heater is all-weather construction, it will last longer and look better if protected from rain and dew.



Install heater to heat the area from the “cold side” if practical. This helps compensate for increased body heat losses on the cold side.

### NOT RECOMMENDED

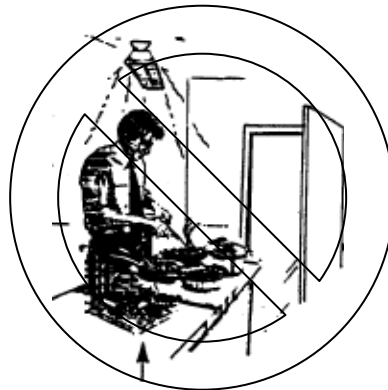

Head too close

Feet too far away

### RECOMMENDED

30 to 60 degrees from horizontal face down. Best angle approx. 45°.



Aim point should be at feet, or on floor behind worker or user.



Warm floor re-radiates heat. Warmer air rises from floor. Some heat reflects from floor.

Mounting a heater directly over a work table or other obstruction will block radiation, primarily heating the object. It is preferably to move the heater to the side, allowing it to heat the floor as well.

### Other Mounting Suggested Locations (120V & 240V)

120V (1500W)

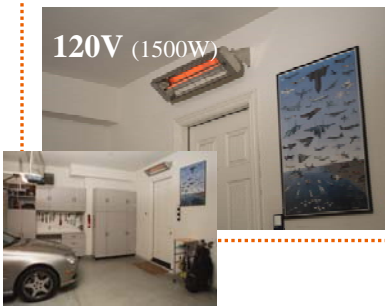

240V (2500 or 3500W)



240V (2500 or 3500W)



240V (2500 or 3500W)



## MOUNTING INSTRUCTIONS – ELECTRIC HEATER

The following information is provided to direct you on how and where to mount **TWIN EAGLES ELECTRIC HEATERS**. Our heaters may be the most economical to install, depending on the location of electrical power adequate to operate the heater(s) properly. All models come with standard wall-ceiling swivel mounting brackets for each side...which **MUST** be used. All hardware is included; reference pictures below to install the brackets to the heater unit.

Twin Eagles Electric Radiant Heaters are UL safety-approved for both outdoors & indoors. \*We recommend model TEEH-1512 (120V, 1500W) to be used in enclosed areas or wind protected areas. For Outdoor or breezy areas, we recommend models TEEH-2524 (240V, 2500W) &/or TEEH-3524 (240V, 3500W).

For the best comfort heating it's usually best to radiate heat onto heating area from two sides rather than from just one side. There are times when it is not practical, in either scenario, reference the information below on this page for heating areas.

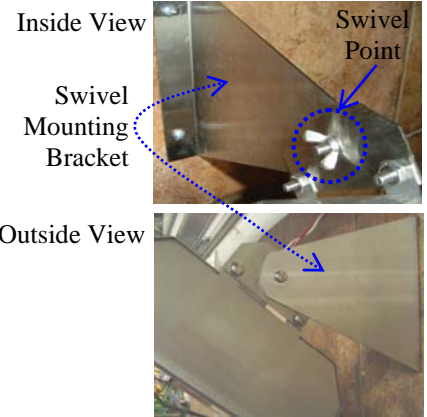

### HEATING AREA COVERED (ref. bottom of pg. 4)

| Model      | Volts | Watts | Amps | Heater Weight | Heater Length | Mounting Height (ft.) | Cold-Breezy (ft.) | Mild (ft.) | Well Protected (ft.) |
|------------|-------|-------|------|---------------|---------------|-----------------------|-------------------|------------|----------------------|
| *TEEH-1512 | 120   | 1500  | 12.5 | 7 Lbs.        | 33"           | 7                     | 3 x 3             | 5 x 5      | 7 x 7                |
| TEEH -2524 | 240   | 2500  | 10.4 | 8 Lbs.        | 39"           | 8                     | 5 x 5             | 7 x 7      | 9 x 9                |
| TEEH -3524 | 240   | 3500  | 14.6 | 13 Lbs.       | 61 1/4"       | 9                     | 7 x 7             | 9 x 9      | 11 x 11              |

#### Vertical Wall Mounted

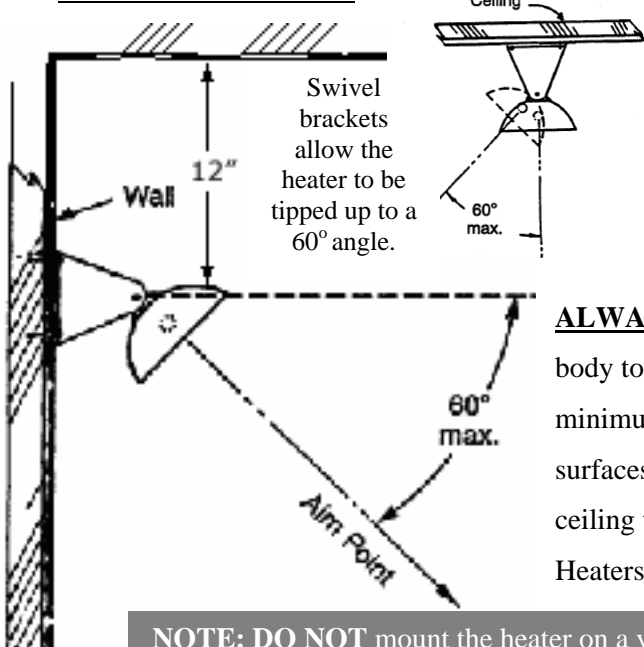

#### Horizontal Ceiling Mounted

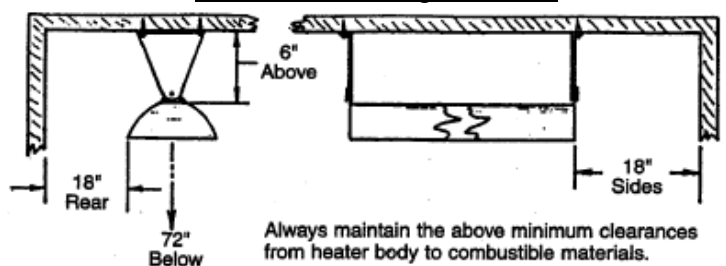

**ALWAYS** maintain the minimum required clearances from heater body to combustible materials. Installation must be such that 18" minimum clearance is maintained between Heater and vertical surfaces. The heater may be wall mounted 12" minimum from the ceiling while maintaining 18" minimum clearance at the ends. Heaters, if mounted in tandem, should be at least 3 feet apart.

**NOTE: DO NOT** mount the heater on a vertical axis. Such installation will reduce the life of the element and will automatically **VOID** the product's warranty. For maximum element life, use a level to find the **Horizontal Axis** position of the heater body. Heater must be leveled but can be swiveled on its horizontal axis.



## WIRING INSTRUCTIONS – ELECTRIC HEATER

Twin Eagles electric heaters are one of the most economical radiant heaters to buy and can be some of the least costly to operate. Twin Eagles electric heaters convert 90% of its input power into radiant heat and only have an electrical consumption of 1.5kW to 3.5kW per hour (varies per heater size).

NOTE:

- a) This heater must be permanently installed and hard wired by a licensed contractor.
- b) Electrical wiring instructions must be performed with no electrical power to the unit.

### **⚠ WARNING**

Never block the front grill of the heater.

The heater is not suitable for hazardous locations.

This unit may be a source of possible shock and ignition.

Do NOT operate within 25 feet of flammable material.

NEVER attempt to service the heater without disconnecting its power source.

- c) Observe local electrical code regulations.
- 1) Check the electrical requirements on UL label located at the rear of the heater for proper voltage. Remove the cover plate from the junction box. Connect power with flexible conduit or appropriate cord to allow heater to be swiveled.
  - 2) Use 12 gauge copper or aluminum wire with a suitable temperature rate for 90°C. Larger gauge may be required for longer wire runs. Your contractor will need to determine this.
  - 3) Once wiring has been completed, screw the cover plate back with the GASKET.

### OUTDOOR INSTALLATION

For outdoor applications, use only wiring components that are UL listed for outdoor use and all electrical connections must be in compliance with the National Electric Code and local codes for outdoor wiring.

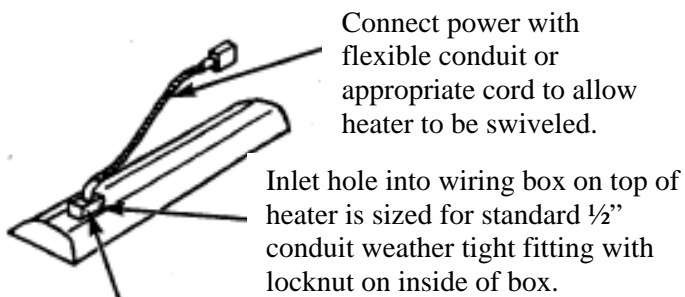

Wiring box on top of heater has a gasket side access cover.

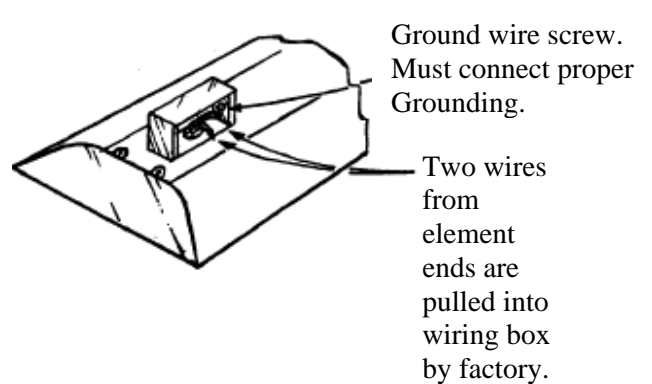

CONTINUE ON NEXT PAGE



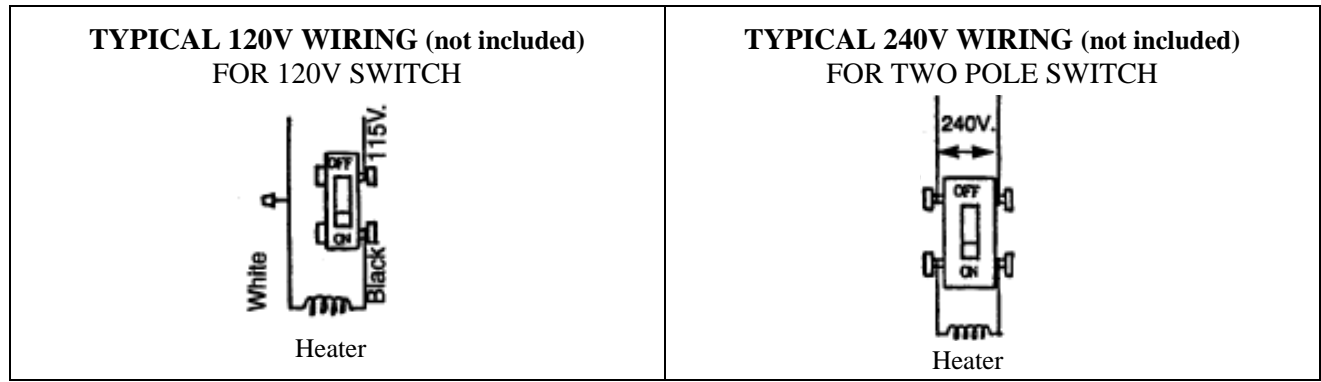

**WIRING FOR OPTIONAL (not included) 120V or 240V INCREMENTAL CONTROL**

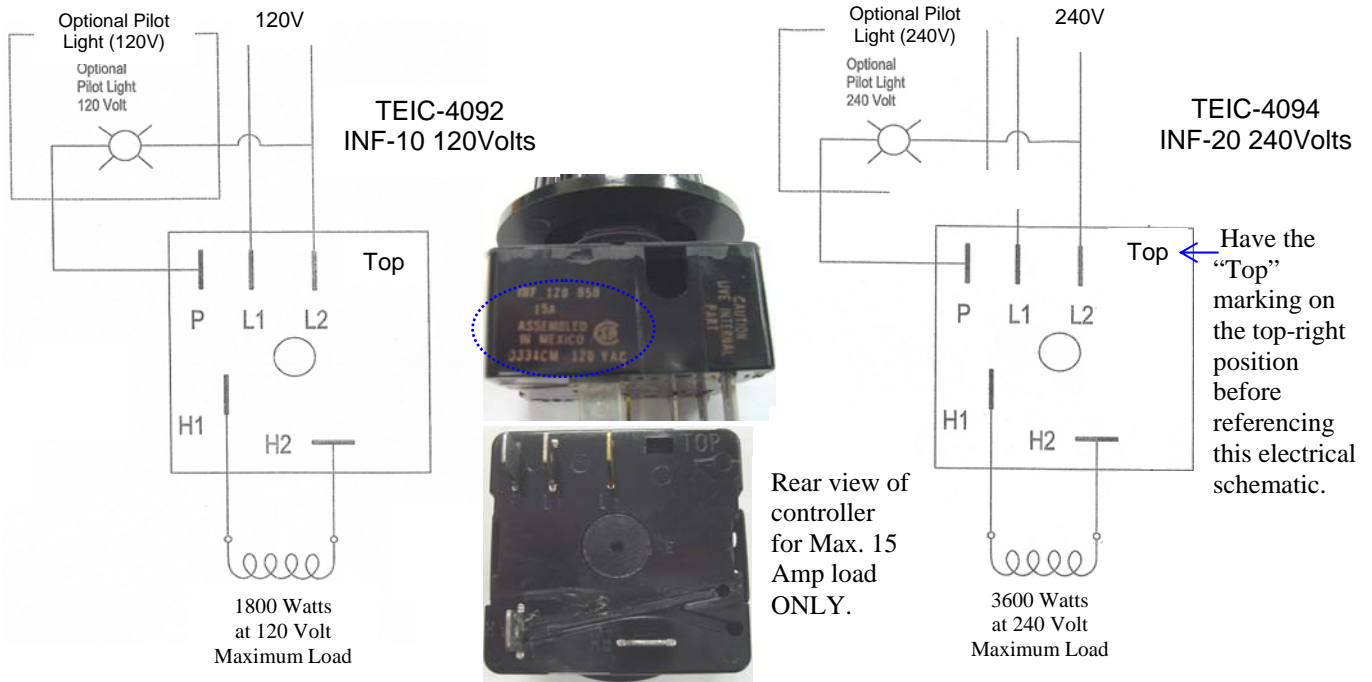

- 4) Once all electrical connections have been completed; mount electrical switch or incremental control on your wall or place of preference as seen on the bottom picture. Before applying power to the unit, check electrical connections against the schematic.

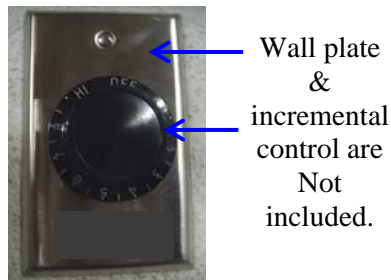

## REPLACEMENT PARTS LIST – ELECTRIC HEATER

| Item Number | Part Number | Part Description                                        | Qty |
|-------------|-------------|---------------------------------------------------------|-----|
| 1           | 16210       | End Reflector Set (2 pcs)                               | 1   |
| 2a          | 16211       | 1500 Body Reflector                                     | 1   |
| 2b          | 16212       | 2500 Body Reflector                                     | 1   |
| 2c          | 16213       | 3500 Body Reflector set (2 pcs)                         | 1   |
| 3a          | 16214       | 1500 safety grill                                       | 1   |
| 3b          | 16215       | 2500 safety grill                                       | 1   |
| 3c          | 16216       | 3500 safety grill                                       | 1   |
| 4           | 16217       | Lead wire set (2 pcs) (NOT SHOWN)                       | 1   |
| 5           | 16218       | Mounting bracket set (2 pcs) (NOT SHOWN)                | 1   |
| 6a          | TERE-1065   | 1500 W 120 V Replacement elements (for TEEH-1512)       | 1   |
| 6b          | TERE-2010   | 2500 W 240 V Replacement elements (for TEEH-2524)       | 1   |
| 6c          | TERE-2053   | 3500 W 240 V Replacement elements (for TEEH-3524)       | 1   |
| 6d          | TERE-2020   | 2500 W 208 V Replacement elements                       | 1   |
| 6e          | TERE-3528   | 3500 W 208 V Replacement elements                       | 1   |
| 7           | 13112       | TWIN EAGLES Logo                                        | 1   |
| 8a          | TEIC-4092   | Incremental Control (120V) INF-10 (for TEEH-1512)       | 1   |
| 8b          | TEIC-4094   | Incremental Control (240V) INF-20 (for TEEH-2524; 3524) | 1   |

For ordering parts, contact Twin Eagles, Inc., Toll free No. 1(800) 789-2206.

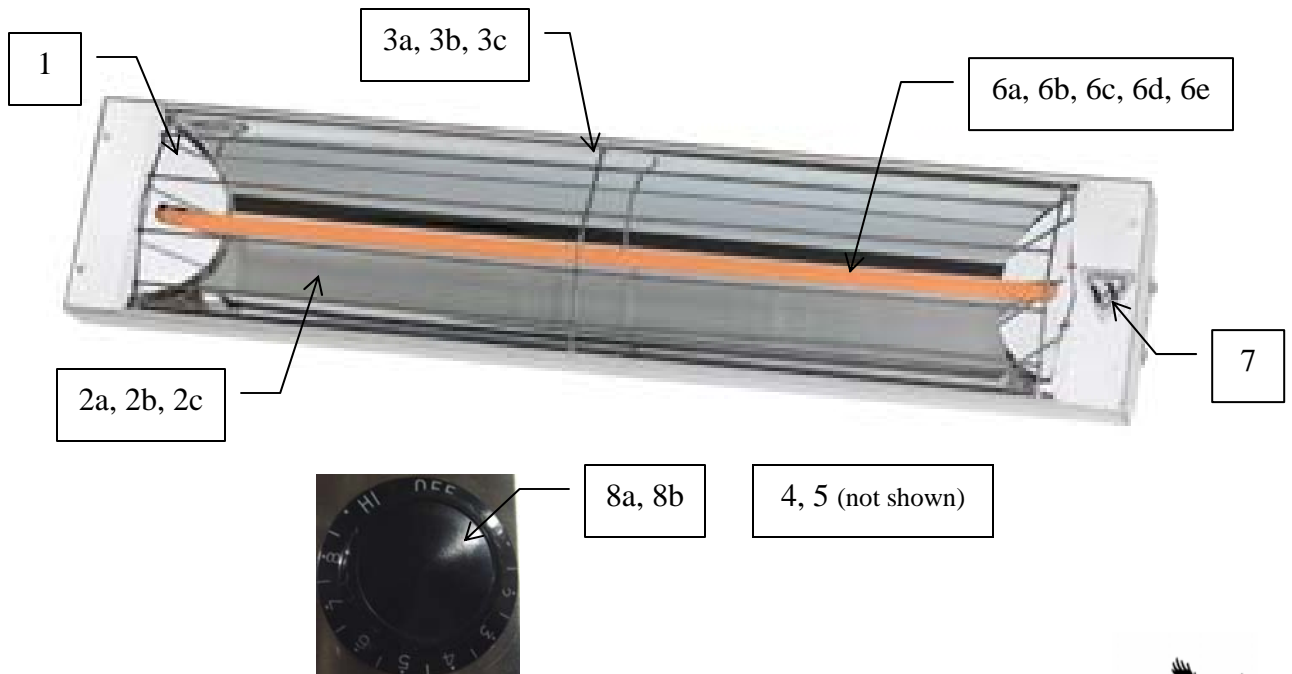



## TROUBLESHOOTING GUIDE – ELECTRIC HEATER

| PROBLEM                                                      | WHAT TO DO                                                                                                                                                             |
|--------------------------------------------------------------|------------------------------------------------------------------------------------------------------------------------------------------------------------------------|
| 1. Heater is warm but not hot. Element does not glow orange. | <ol style="list-style-type: none"><li>1. Check for low voltage</li><li>2. If voltage is 208 volts, use element rated for 208 volts instead of 240 volts.</li></ol>     |
| 2. Element does not come on at all.                          | <ol style="list-style-type: none"><li>1. Check if there is power to the unit.</li><li>2. Check for proper connection of line 1 and line 2 on the controller.</li></ol> |
| 3. Element glows orange but the heater is not hot enough     | <ol style="list-style-type: none"><li>1. Check recommended mounting height against model.</li></ol>                                                                    |
| 4. Element glows unevenly from end to end.                   | <ol style="list-style-type: none"><li>1. Check if heater is horizontally leveled.</li></ol>                                                                            |



# TWIN EAGLES ELECTRIC HEATER

## Limited Product Warranty

Model: \_\_\_\_\_

Serial No: \_\_\_\_\_

Date of Purchase: \_\_\_\_\_

Selling Dealer: \_\_\_\_\_

*Thank you very much for purchasing a high quality Electric Heater from Twin Eagles, Inc. We have designed this heater to provide you and your family with many years of great comfort heating experiences. Please fill in the Model and Serial number as well as date of purchase in the areas indicated above. Please save this information for future reference. To get the full and safe enjoyment for your electric heater please read your Owner's Manual carefully and review the proper operating and safety instructions with any family members that may be using the heater.*

**Manufacturer Warranty:** Twin Eagles warrants that this electric heater is designed and manufactured to be free from defects in materials and workmanship for a period of one year from original date of purchase. For commercial application a 90 day warranty applies.

**Extent of Warranty:** This warranty shall apply only to the products delivered in the continental United States and Canada. It extends to the selling dealers to the original purchaser at the original site of installation: This warranty becomes valid at the time of purchase and ends either by specified timeframe listed above, owner transfer or relocation. *In order to activate the warranty we require that you send in the attached warranty registration card. This registration is for our internal use only and will only be used in the event we need to send you important safety related product information. The information will not be sold or used for any marketing related purposes.*

**Warranty Performance:** In the event of malfunction or defect covered under the terms of this warranty, the factory authorized selling dealer and or **authorized distributor** is responsible for performing all necessary repairs. All field service costs are not covered in any way by this warranty. To obtain service, contact the authorized selling dealer. In the event the consumer is unable to obtain satisfactory customer service from the authorized dealer, please call us directly at (562) 802-3488. We may require that a written notification be submitted to Twin Eagles Customer Service Department within ten (10) days of the reported failure. *There will be no charge for parts if they are covered under our warranty.*

If Twin Eagles determines that repair of a covered item is not feasible, Twin Eagles reserves the right to replace the defective merchandise. In the event of any warranty replacement, all removal, replacement, installation and shipping costs are the responsibility of the electric heater owner.

**Warranty Limitations and Exclusions:** This warranty does not apply to damages resulting from negligence, alteration, misuse, abuse, accident, natural disaster, improper installation or improper operation, unauthorized adjustments or calibrations, dings, dents, scratches, nor damages due to harsh chemicals (i.e. cleaning products improperly applied). Warrantor is not responsible for consequential or incidental damages. Under no circumstances shall Twin Eagles or any of its representatives be held liable for injury to any person or damage to any property, however arising. *This warranty does not apply to products with altered or removed serial numbers.*

**Important: Please retain original proof of purchase to establish warranty period.**

Any implied warranties of merchantability and fitness applicable to the equipment are limited in duration to the period of coverage of this express written warranty. This warranty grants specific legal rights to the purchaser. Other rights, which may vary from state to state, may also apply. Title to the merchandise passes to the consignee upon acceptance by the carrier. After acceptance by the carrier, the merchandise travels at the risk of the purchaser. In the event of freight damage, do not refuse shipment. Advise both the freight agent and the shipper of the damage. Note the details of that damage on the freight bill before any freight charges are paid and file a claim for damages with the freight agent.

*Twin Eagles Products-Crafted With Pride in the USA*



Place  
Postage  
Here



Customer Service  
ATTN: Warranty Department  
13231 East 166<sup>th</sup> Street  
Cerritos, CA 90703  
Fax no. (562) 802-3391

Cut  
Here

Fold Here



## Warranty Registration

|               |                  |
|---------------|------------------|
| Customer Name | Model #          |
| Address       | Serial #         |
| City          | Date Purchased   |
| Zip           | Dealer's Name    |
| Phone #       | Dealer's Address |
| e-mail:       |                  |

This Warranty Registration card must be returned within thirty days of purchased to properly activate your warranty.  
This information is for our internal use only.

A