

Product Dimensions

Decorator Wall Hood

DA399-5

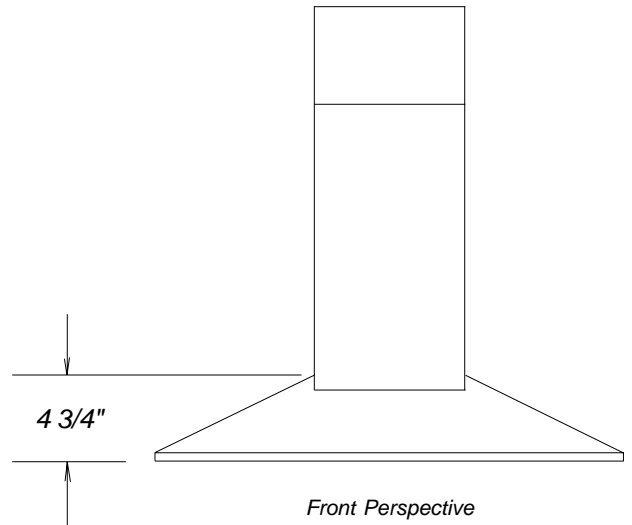
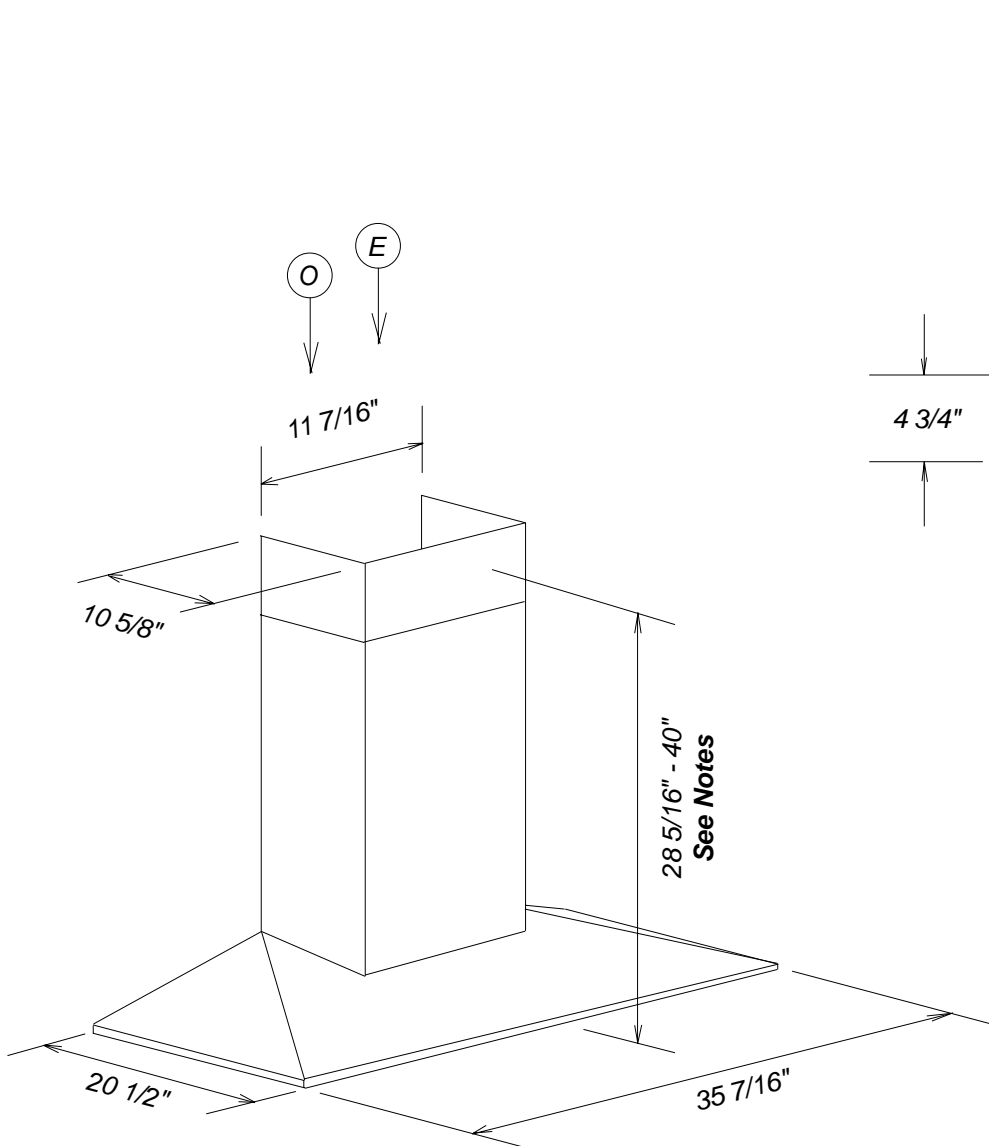

Location Codes
<p>E - 110 Volt - 15 Amp 3-wire power supply connects through top or rear of chimney.</p> <p>O - Standard 110 Volt Outlet</p>
Notes
<ul style="list-style-type: none"> All installations must be done in accordance with local codes. Recirculation: 32 11/16" - 45 1/4" 6" duct connects to blower system inside chimney.

NOTE: Drawing is not to scale.
SPECIFICATION SHEETS 021111

Installation Dimensions

Decorator Wall Hoods

DA399-5

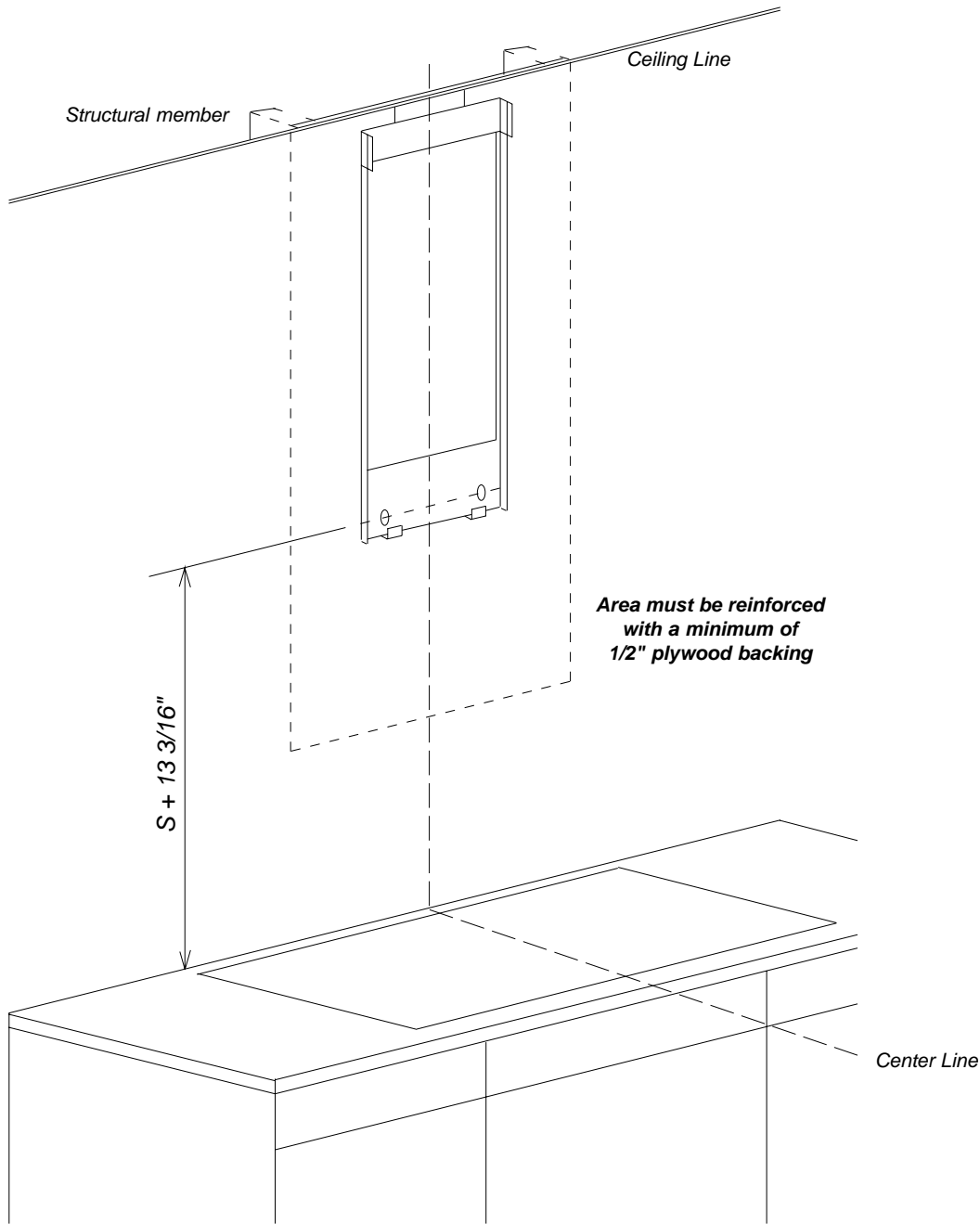

Notes

- Center unit over cooking surface
- Distance "S" is determined by the cooking surface. Minimum distance "S" is:
 - 18" for electric surfaces
 - 26" for gas surfaces
- Area behind mounting plates **MUST** be reinforced using a minimum of 1/2" plywood. Reinforcing material should be affixed to structural wall members

NOTE: Drawing is not to scale.
SPECIFICATION SHEETS 021111