

TRANSITIONS AND DAMPERS



Model 411 Transition

- 3¼" x 10" to 6" round
- Model 412H Transition**
- 3¼" x 10" to 7" round
- Model 413 Transition**
- 3¼" x 10" to 8" round

All models above -
30 GA galvanized steel construction

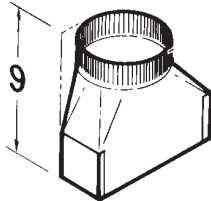

Model 423 Transition

- 4½" x 18½" to 10" round - vertical discharge
- 26 GA galvanized steel construction

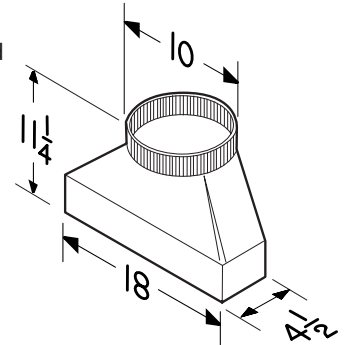

Model 414 Transition

- 10" round to 8" round
- 24 GA galvanized steel

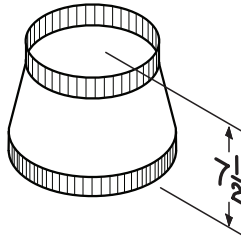

Model 424 Transition

- 4½" x 18½" to 10" round horizontal, rear discharge
- 26 GA galvanized steel construction

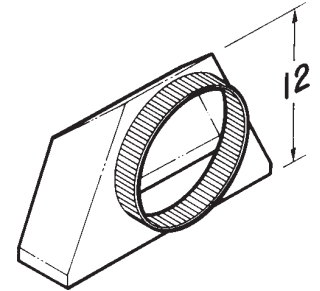

Model T486 Transition

- 8" round to 6" round
- 30 GA galvanized steel

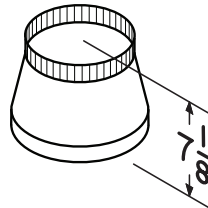

Model 427 Transition

- 4½" x 18½" to 10" round horizontal discharge
- 26 GA galvanized steel construction

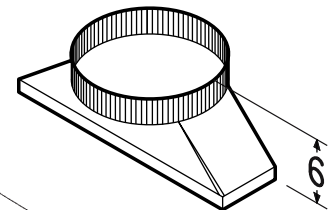

Model T487 Transition

- 8" round to 7" round
- 24 GA galvanized steel

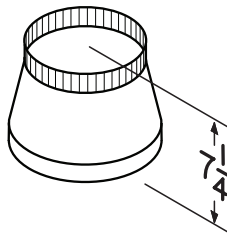

Model 453 Transition

- 4½" x 18½" to 10" round horizontal, left discharge
- 26 GA galvanized steel construction

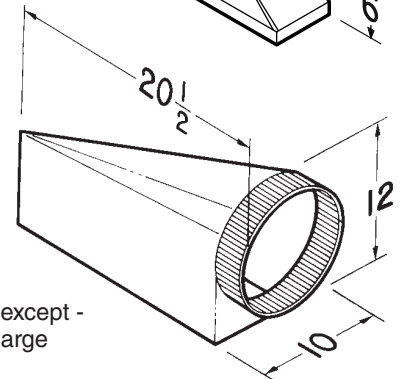

Model 454 Transition

- Same as Model 453 except - horizontal right discharge

Broan-NuTone LLC Hartford, Wisconsin www.broan.com www.nutone.com 800-558-1711
Broan-NuTone Canada Mississauga, Ontario www.broan.ca 877-896-1119

REFERENCE	QTY.	REMARKS	Project
			Location
			Architect
			Engineer
			Contractor
			Submitted by Date

Model 459 Transition

- 3 1/4" x 14" to 8" round - vertical discharge
- 30 GA galvanized steel construction

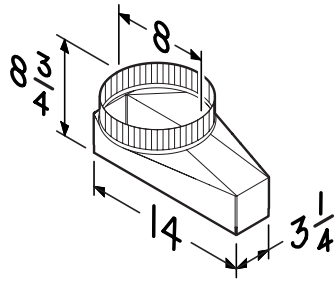

Model T460 Transition

- 3 1/4" x 14" to 7" round - vertical discharge
- 30 GA galvanized steel construction

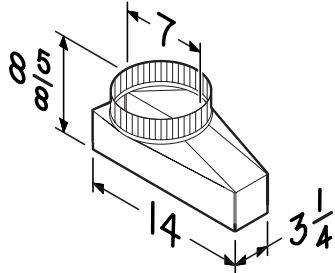

Model T462 Transition

- 3 1/4" x 14" to 6" round - vertical discharge
- 30 GA galvanized steel construction

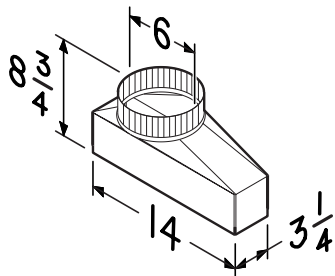

Model 472 Transition / Damper

- 10" round to 8" round
- Spring-loaded aluminum louvers
- Rubber stops
- 24 GA galvanized steel

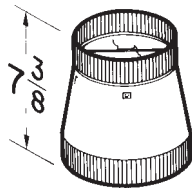

Model 475 Transition

- 6" round to 4" round
- Black, polymeric construction

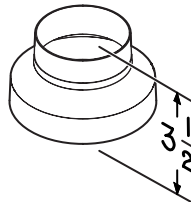

Model 475B Transition

- Six-pack of Model 475

Model T81212 Transition

- 8" x 12" to 12" round
- 28 ga. galvanized steel

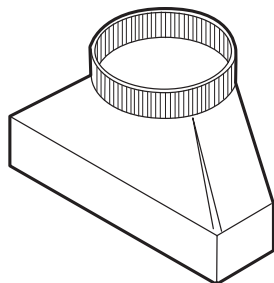

Model S99610015 Transition

- 8" x 12" to 10" round male - vertical discharge
- 26 GA galvanized steel construction

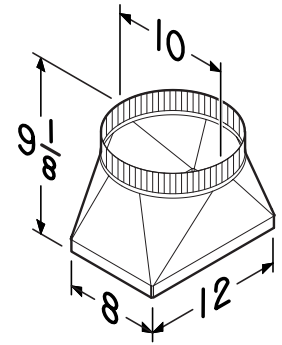

Model S99610028 Transition

- 8" x 12" to 10" round female - vertical discharge
- 26 GA galvanized steel construction

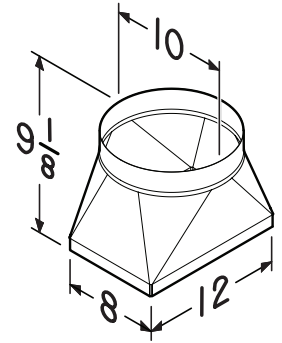

Model BP87 Damper

- 7" round
- Extruded steel with electrically-bonded epoxy finish
- .016 Aluminum louvers

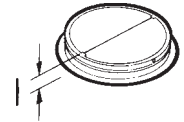

Model BP87Q Damper

- 7" round
- Extruded steel with electrically-bonded epoxy finish
- .016 Aluminum louvers
- Sound dampening foam

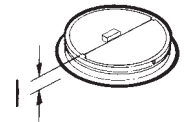

Model 97 Damper

- 7" round
- 28 GA galvanized steel
- Aluminum louvers

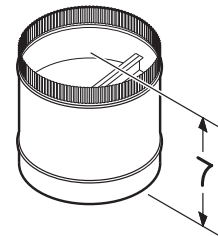

Model 421 Damper

- 10" round
- 24 GA galvanized steel with aluminum louvers

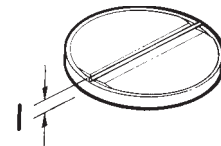

Model 438 Damper

- 8" round
- 24 GA galvanized steel with aluminum louvers

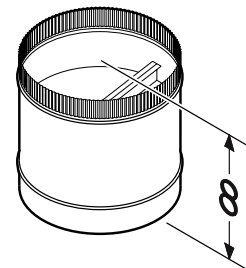

BROAN
NuTone

Broan-NuTone LLC Hartford, Wisconsin
www.broan.com www.nutone.com 800-558-1711

Broan-NuTone Canada Mississauga, Ontario
www.broan.ca 877-896-1119