

Viking Range, LLC
111 Front Street
Greenwood, Mississippi 38930 USA
(662) 455-1200

For product information,
call 1-888-(845-4641)
or visit our web site at vikingrange.com in the US or
brigade.ca in Canada

Use & Care Manual



15" W. Undercounter/Freestanding Nugget Ice Machine

Congratulations

We hope you will enjoy and appreciate the care and attention we have put into every detail of your new, state-of-the-art ice machine.

Your new appliance is designed to offer years of reliable service. This Use and Care Guide will provide you with the information you need to become familiar with your ice machine's care and operation.

Your complete satisfaction is our ultimate goal. If you have any questions or comments about this product, please contact the dealer from whom you purchased it, or contact our Consumer Support Center at 1-888-845-4641.

We appreciate your choice of ice machine and hope that you will again select our products for your other major appliance needs.

For more information about the complete and growing selection of products, contact your dealer or visit us online at vikingrange.com in the US or brigade.ca in Canada.

Table of Contents

Important Safety Instructions _____	4
Initial Start Up _____	5
Use _____	5
Maintenance _____	8
Care and Cleaning _____	9
Troubleshooting Guide _____	15
Service Information _____	16
Warranty _____	17

Important - Please read and follow

- Before beginning, please read these instructions completely and carefully.
- **DO NOT** remove permanently affixed labels, warnings, or plates from the product. This may void the warranty.
- Please observe all local and national codes and ordinances.
- Please ensure that this product is properly grounded.
- The installer should leave these instructions with the consumer who should retain for local inspector's use and for future reference.

⚠ WARNING

To reduce the risk of fire, electric shock, or injury when using your unit, follow these basic precautions:

- Read all instructions before using the unit.
- Never allow children to operate, play with, or crawl inside the unit.
- Never clean unit parts with flammable fluids. The fumes can create a fire hazard or explosion.
- Always turn the power on/off switch (located behind the air grille on top right side) to the OFF position before attempting to change light bulbs, clean, or service the unit.

FOR YOUR SAFETY

DO NOT STORE OR USE GASOLINE OR OTHER FLAMMABLE VAPORS AND LIQUIDS IN THE VICINITY OF THIS OR ANY OTHER APPLIANCE. THE FUMES CAN CREATE A FIRE HAZARD OR EXPLOSION.

It is your responsibility to be sure your ice machine is:

- located so the front is not blocked to restrict incoming or discharge air flow.
- properly leveled.
- located in a well ventilated area.
- connected to the proper kind of outlet, with the correct electric supply and grounding. A 115V, 60 Hz, 15 amp fused electrical supply is required. **Note:** *Time delay fuse or circuit breaker is recommended.*
- not used by anyone unable to operate it properly.
- used only for its intended purpose.
- properly maintained.

•SAVE THESE INSTRUCTIONS•

Initial Start Up

1. Turn on the water supply.
2. Switch on the electrical power.
3. Push and release the On/Off switch to start the machine. The Ice Making light next to the On/Off switch will glow Blue.

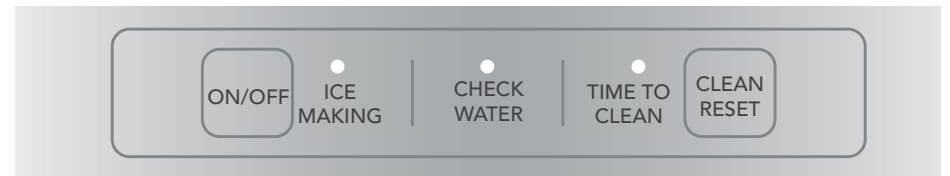

Warm air will flow out of the left front grill.

It will take about 10 minutes for the ice machine to begin dropping nugget ice into the storage bin. It is normal for that ice to melt and ice will continue to melt, but at a slower rate. It will take about 6 - 7 hours to fill up the ice storage bin. The bin holds about 20 lb of ice when full.

Ice level control

The ice level control is an ultrasonic sensor, located above the ice storage area. It is automatic and there is no adjustment to make. When ice melts or is used, and the ice level drops below a preset distance the control turns the ice making system back on. It makes ice until the preset level is reached. Placing your hand in the unit to remove ice does not affect the ice level.

Using Your Ice Machine

No special instructions are needed for use. Just take as much ice as you need, the machine will replace it. A scoop is provided, and it can be stored in the machine using the loop of tubing on the right side as a holder.

The machine can be shut off anytime by just pushing and releasing the ON/OFF button. During the ice making, nugget ice will drop into the bin at an irregular rate. Sometimes there will be little ice falling while at other times, a group of nuggets will fall. Some water drops may also come out with the ice. Both conditions are normal.

It is designed to operate in wide range of air temperatures:

- Minimum air temperature: 50 degrees F.
- Maximum air temperature: 100 degrees F.

Using Your Ice Machine (con't)

Although the machine will function within the listed ranges, it works best at water temperatures between 50 and 60 and air temperatures between 60 and 80.

Note: Ice making capacity goes down as the environmental temperatures go up, and will be severely reduced at temperatures over 90°F.

Operating a unit outside of the limits can cause problems that are not covered by the warranty and, if extreme, cause damage to the unit.

Never keep anything in the ice storage bin that is not ice. Objects like wine or beer bottles are not only unsanitary, but the labels can slip off and plug up the drain.

Never allow the machine to operate without regular cleaning. The machine will last longer if it is kept clean. Regular cleaning should happen at least once per year, and preferably twice. Some water conditions will dictate even more frequent cleaning of the ice making section, and some carpets or pets will dictate more frequent cleaning of the condenser.

Note: *The Time to Clean light will switch ON after 6 months of use. It will remain ON until the ice making system is cleaned using the process in the "How to clean the condenser and winterize" section.*

Noise

The ice machine is designed for quiet operation, but will make some noise during the ice making cycle.

OUTDOOR USE

Keep from freezing. Severe damage will occur to the unit if left in or operated in temperatures beyond the limits listed in this manual. That damage is NOT covered by warranty.

Keep dry. Do not locate in low lying areas where puddles will accumulate.

Provide Shade: Heat gain from the sun will reduce the unit's ability to make and store ice, and ultraviolet radiation from the sun can potentially damage the unit's plastic components.

Using Your Ice Machine (con't)

Water Supply: Avoid a long run of hose or tubing exposed to the sun. Plastic water supply tubing should be rated for potable water and include UV protection. Copper tubing is recommended.

Back Flow Prevention: The unit includes back flow prevention, no additional check valve is required.

Drainage: Do Not drain into swimming pool or onto grounds.

WATER QUALITY

The water to the machine must be potable, or fit for human consumption. Beyond that, water supplies vary in the degree of mineral content. As this ice machine makes ice, all the water that flows into the machine is changed into ice. That includes any minerals that might be in the water. However, during ice making some minerals will stick to the ice making components. The higher the mineral content, the more mineral build up will occur. Water filters are a partial help, as they will remove the suspended solids, but water treatment is needed for the dissolved solids, which are part of the water and cannot be filtered out.

RO Water

This machine can be supplied with Reverse Osmosis water, but the water conductivity must be no less than 10 microSiemens/cm. A reverse osmosis system should include post treatment or blending to satisfy the R.O. water's potential aggressiveness.

Deionized water is not recommended and could damage the machine. Because water softeners exchange one mineral for another, softened water may not improve water conditions when used with ice machines

Maintenance

We strongly recommend regular maintenance of this ice machine.

During normal operation mineral scale that is in the water supply will gradually build up on the ice making surfaces. That build up can cause excessive loading of the ice making system, which can cause premature failure. Regular removal of the mineral scale will lengthen the product's life.

Suggested maintenance schedule: every 6 months.

Type of maintenance: Scale removal, water seal check, water reservoir check, bin drain check, air cooled condenser cleaning and storage bin sanitation.

Care and Cleaning

Condenser cleaning

The condenser is like the radiator on a car, it has fins and tubes that can become clogged with dirt and lint.

To clean:

1. Remove the kickplate and front service panel.

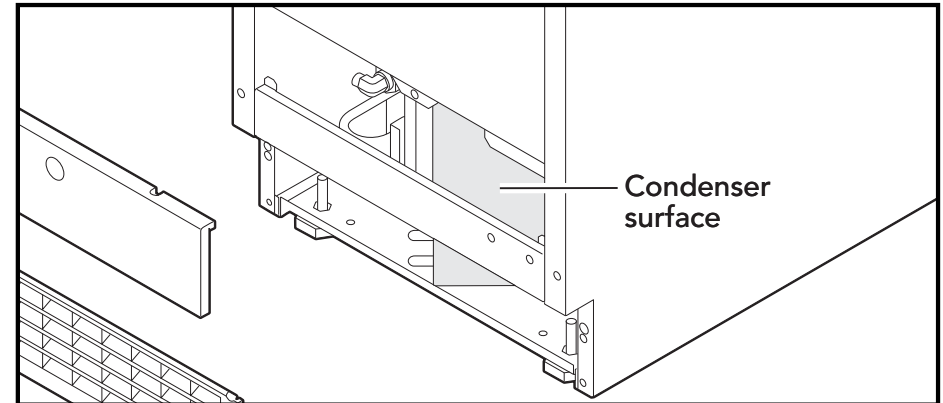

2. Locate the condenser surface.
3. Vacuum the surface, removing all dust and lint.



CAUTION

DO NOT dent the fins.

4. Return the kickplate and front service panel to their original positions. Fasten them to the cabinet using the original screws.

Winterizing

1. Clean the ice making system.
2. Open the door and push and release the On/Off switch to turn the machine off.
3. Turn off the water supply.
4. Remove the back wall of the ice storage bin.
5. Remove the drain plug and drain water reservoir. Return plug to its original position.
6. Drain pump models should have about 1/2 gallon of RV antifreeze (propylene glycol) poured into the ice storage bin drain.
Note: Automotive antifreeze must **NOT** be used.
7. Switch off and unplug the machine.

Care and Cleaning (con't)

How to remove scale from the ice making system.

Cleaning this machine involves adding a solution of scale remover and water to the ice machine and continuing to add it as it makes ice. The scale remover must be diluted to the correct ratio. A squirt bottle will make adding the scale remover much easier when the unit is built in. If not built in, remove the top panel for reservoir access.

Recommended tools: Rubber gloves, squirt bottle & scale remover.

1. Scoop out and discard all of the ice.
2. Press and release the On/Off button.

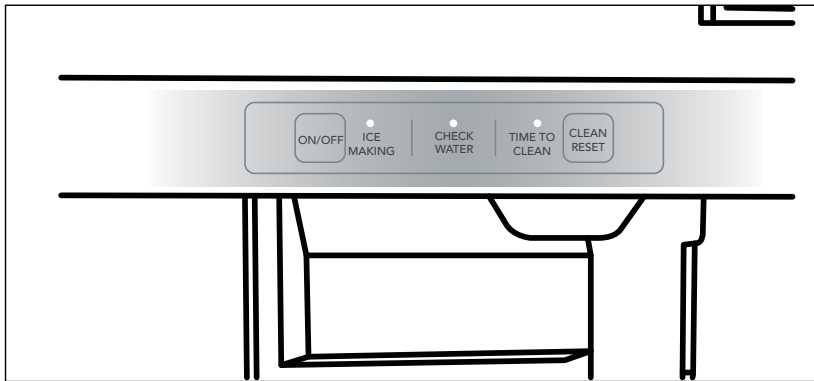

3. Open door and locate screws at upper back wall of bin. Remove the two screws

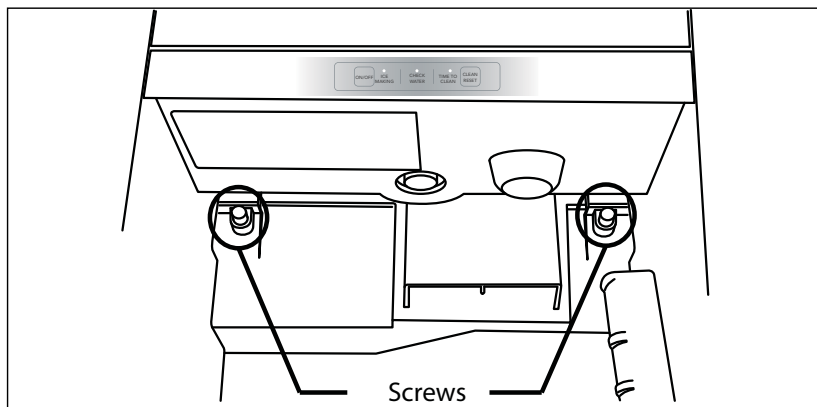

4. Remove the back panel of the bin by lowering it down past the scoop holder, feel free to rotate the scoop holder loop down to make more room.

Care and Cleaning (con't)

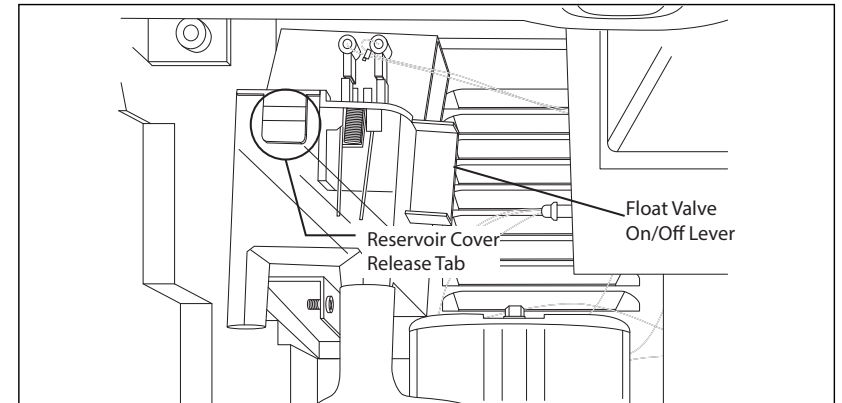

5. Push tab on front edge of reservoir cover and remove the cover.
Note: Adjacent wires are low voltage and are not hazardous.

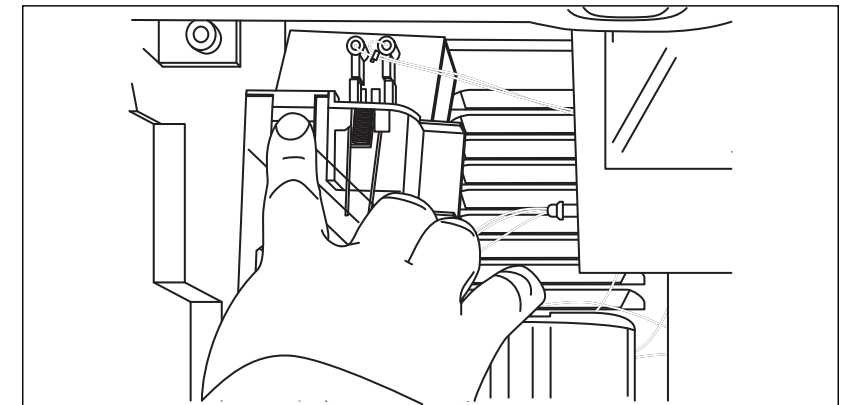

Push Tab

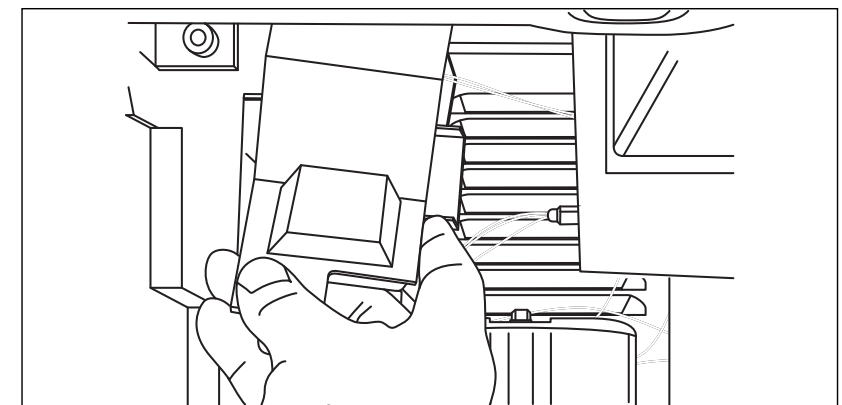

Lift reservoir cover to remove

Care and Cleaning (con't)

6. Locate blue float valve on/off lever. Move lever up about half way to shut water off.
7. Locate drain plug and pull the drain plug out to drain the reservoir and evaporator. When draining is complete, return the plug to its original position.
8. Mix a solution of cleaner with water: 1.25 ounces of cleaner with 16 oz of warm water.

⚠ WARNING



Ice machine scale remover contains acids. Acids can cause burns.

If concentrated cleaner comes in contact with skin, flush with water. If swallowed, DO NOT induce vomiting. Give large amounts of water or milk. Call Physician immediately. Keep out of the reach of children.

Note: Take care not to spill any scale remover on any nearby surface. Immediately wipe any spill with baking soda and water.

9. Fill the 16 oz squirt bottle with the diluted scale remover.
10. Fill the reservoir with the scale remover solution using squirt bottle or other container. That will be about 8 ounces or half a squirt bottle.

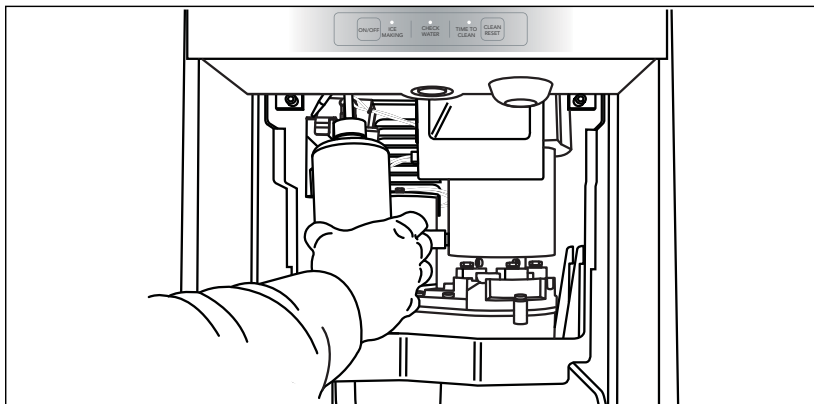

Care and Cleaning (con't)

11. Press and HOLD both the Clean-Reset and On/Off buttons for 5 seconds. The Time to Clean light will blink on and off.

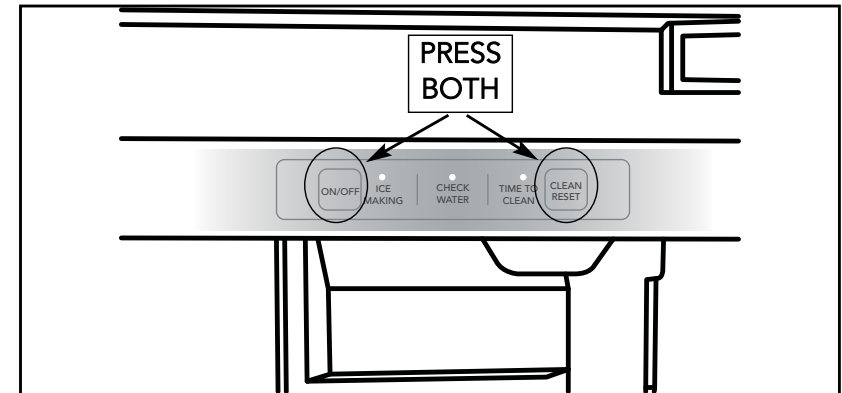

12. The auger motor alone will be operating for 10 minutes, after that the compressor will start and in about 5-8 minutes the machine will start to make ice. The Time to Clean light will now glow steady until the clean cycle is complete.

Caution: Keep fingers away from moving parts.

After ice making starts, continuously add scale remover solution to the reservoir to keep it about half full.

When all 16 oz of the solution is used, move the float valve lever down to the On position.

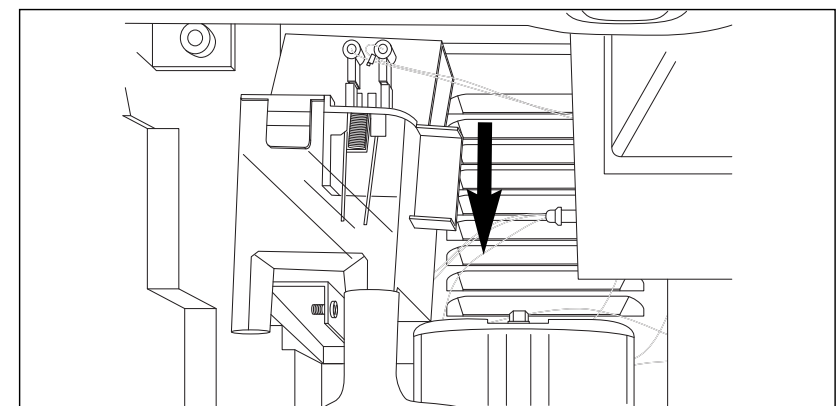

Care and Cleaning (con't)

After 40 minutes the ice machine and all the control panel lights will shut off.

13. Pull the drain plug again to drain the system, then replace it.
14. Return the reservoir cover to its original position.
15. Return the upper back wall of the bin to its original position and secure it with the original screws. Push in to snap it into place.
16. Pour a gallon of hot (95oF. – 115oF.) water into the bin to flush out the drain and melt all ice that was made during the cleaning process. Be sure all ice is melted.
17. Clean the bin liner of mineral scale by using any left over scale remover solution to scrub the scale off of the liner. If none is left over, mix a solution of 2.5 ounces of Clear 1 Scale Remover and 1 quart of water.
18. Rinse the liner with hot water.
19. Sanitize the bin interior.
20. Push and release the On/Off button to restart ice making.

The ice scoop should be washed regularly, wash it just like any other food container.

Other Maintenance

Note: It is normal for some lime scale to form on the gear reducer cover. Wipe up any loose scale.

Check the top bearing.

The top bearing is non-metallic and requires no lubrication. However, it should be checked for wear occasionally. The top panel must be removed to access the bearing. The wear limit is 1/64", and can be checked with a pin gauge.

Troubleshooting Guide

PROBLEM	CORRECTION
Low capacity	<ul style="list-style-type: none">• Check for restricted drain or standing water in the bin.• Clean the air cooled condenser fins.• Clean the ice machine system.
No ice	<ul style="list-style-type: none">• Check On/Off switch.• Check electrical breaker.• If the "Check Water" light is flashing blue, check water supply. The control system checks for water every 20 minutes. When the water supply is restored, the machine will automatically restart ice making.
"Time to Clean" light is on	<ul style="list-style-type: none">• Clean the ice making system

Service Information

If service is required after checking the troubleshooting guide, call your dealer or authorized service agency. The name of the authorized service agency can be obtained from the dealer or distributor in your area.

When you make a service call, be sure to have the following information handy:

- Model Number
- Serial Number
- Date of Purchase
- Name of dealer from whom purchased

Be ready to clearly describe the problem that you are having with your ice machine.

If you are unable to obtain the name of an authorized service agency, or if you continue to have service problems, contact Viking Range, LLC at 1-888-845-4641 or write to:

**VIKING RANGE, LLC
PREFERRED SERVICE
111 Front Street
Greenwood, Mississippi 38930 USA**

Record the following information indicated below. You will need it if service is ever required.

The serial number and model number for your ice machine is located under the control panel in the upper compartment.

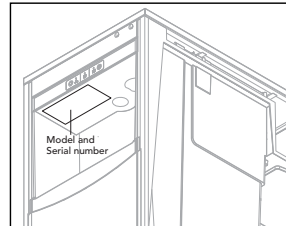

Model No.....Serial No.

Date of Purchase..... Date Installed.....

Dealer's Name.....

Address.....

If service requires installation of parts, use only authorized parts to insure protection under the warranty.

Keep this manual with your ice machine for future reference.

Warranty

FGNI/FPNI UNDERCOUNTER/FREESTANDING ICE MACHINE WARRANTY

THREE YEAR FULL WARRANTY

Undercounter/freestanding ice machines and all of their components and accessories, except as detailed below, are warranted to be free from defects in material or workmanship under normal household use for a period of three (3) years from the date of original retail purchase. Viking Range, LLC, warrantor, agrees to repair or replace, at its option, any part which fails or is found to be defective during the warranty period.

*Painted and decorative items are warranted to be free from defective materials or workmanship for a period of ninety (90) days from the date of original retail purchase. ANY DEFECTS MUST BE REPORTED TO THE SELLING DEALER WITHIN NINETY (90) DAYS FROM DATE OF ORIGINAL RETAIL PURCHASE.

***FULL NINETY (90) DAY COSMETIC WARRANTY:** Product is warranted to be free from cosmetic defects in materials or workmanship (such as scratches on stainless steel, paint/porcelain blemishes, etc.) for a period of ninety (90) days from the date of original retail purchase or closing date for new construction, whichever period is longer. Any defects must be reported to the selling dealer within ninety (90) days from date of original retail purchase. Viking Range, LLC uses high quality processes and materials available to produce all color finishes. However, slight color variation may be noticed because of the inherent differences in painted parts and porcelain parts as well as differences in kitchen lighting, product locations, and other factors. Therefore, this warranty does not apply to color variation attributable to such factors.

†FULL NINETY (90) DAY WARRANTY IN "RESIDENTIAL PLUS" APPLICATIONS: This full warranty applies to applications where use of the product extends beyond normal residential use, but the warranty period for products used in such applications is ninety (90) days. Examples of applications covered by this warranty are bed and breakfasts, fire stations, private clubs, churches, yachts, etc. Under this "Residential Plus" warranty, the product, its components and accessories are warranted to be free from defective material or workmanship for a period of ninety (90) days from the date of original retail purchase. This warranty excludes use of the product in all commercial locations such as restaurants, food service locations and institutional food service locations.

SIX YEAR FULL WARRANTY ON SEALED REFRIGERATION PARTS AS LISTED

Any sealed refrigeration system component, as listed below, is warranted to be free from defective materials or workmanship in normal household use during the fourth through the sixth year from the date of original retail purchase. Viking Range, LLC, warrantor, agrees to repair or replace, at its option, any part which fails or is found to be defective during the warranty period.

Sealed Refrigeration System Components: Compressor, Evaporator, Condenser, Connecting Tubing, Dryer/Strainer

TWELVE YEAR LIMITED WARRANTY ON SEALED REFRIGERATION PARTS AS LISTED

Any sealed refrigeration system component, as listed above, which fails due to defective materials or workmanship in normal household use during the seventh through the twelfth year from the date of original retail purchase will be repaired or replaced, free of charge for the part itself, with the owner paying all other costs, including labor.

LIMITED LIFETIME WARRANTY

During the life of the product, any stainless steel parts found to be defective in material or workmanship will be repaired or replaced, free of charge for the part itself, with the owner paying all other costs including labor. This warranty excludes surface corrosion or rust, scratches, discoloration, water or atmospheric conditions, or cleaning practices which are part of normal residential use.

TERMS AND CONDITIONS

This warranty extends to the original purchaser of the product warranted hereunder and to each transferee owner of the product during the term of the warranty and applies to products purchased and located in the United States, Canada, Mexico, and the Caribbean (excluding Cuba, Dominican Republic, and Haiti). Products must be purchased in the country where service is requested. If the product or one of its component parts contains a defect or malfunction during the full warranty period after a reasonable number of attempts by the warrantor to remedy the defect or malfunction, the owner is entitled to either a refund or replacement of the product or its component part or parts. Replacement of a component part includes its free installation, except as specified under the limited warranty. Under the terms of this warranty, service must be performed by a factory authorized Viking Range, LLC service agent or representative. Service will be provided during normal business hours, and labor performed at overtime or premium rates shall not be covered by this warranty.

Owner shall be responsible for proper installation, providing reasonable and necessary maintenance, providing proof of purchase upon request, and making the appliance reasonably accessible for service. The return of the Owner Registration Card is not a condition of warranty coverage. You should, however, return the Owner Registration Card so that Viking Range, LLC can contact you should any question of safety arise which could affect you.

This warranty gives you specific legal rights, and you may also have other rights which may vary from jurisdiction to jurisdiction.

Warranty

WHAT IS NOT COVERED BY THIS WARRANTY: This warranty shall not apply to damage resulting from abuse, failure to provide reasonable and necessary maintenance, accident, delivery, negligence, natural disaster, loss of electrical power to the product for any reason, alteration, outdoor use, improper installation, improper operation, or repair or service of the product by anyone other than an authorized Viking Range, LLC service agency or representative. This warranty does not apply to commercial usage.

LIMITATION OF REMEDIES AND DURATION OF IMPLIED WARRANTY

OWNER'S SOLE AND EXCLUSIVE REMEDY FOR A CLAIM OF ANY KIND WITH RESPECT TO THIS PRODUCT SHALL BE THE REMEDIES SET FORTH ABOVE. VIKING RANGE, LLC IS NOT RESPONSIBLE FOR CONSEQUENTIAL OR INCIDENTAL DAMAGE, INCLUDING BUT NOT LIMITED TO FOOD OR MEDICINE LOSS, DUE TO PRODUCT FAILURE, WHETHER ARISING OUT OF BREACH OF WARRANTY, BREACH OF CONTRACT OR OTHERWISE. Some jurisdictions do not allow the exclusion or limitation of incidental or consequential damages, so the above limitation or exclusions may not apply to you. **ANY IMPLIED WARRANTIES OF MERCHANTABILITY OR FITNESS FOR A PARTICULAR PURPOSE APPLICABLE TO THIS PRODUCT ARE LIMITED IN DURATION TO THE PERIOD OF COVERAGE OF THE APPLICABLE EXPRESS WRITTEN LIMITED WARRANTIES SET FORTH ABOVE.** Some states do not allow limitations on how long an implied warranty lasts, so the above limitation may not apply to you.

WARRANTY SERVICE

To obtain warranty service, contact an authorized Viking Range, LLC service agent, or Viking Range, LLC, 111 Front Street, Greenwood, Mississippi 38930, (888) 845-4641. Provide model and serial number and date of original purchase or closing date for a new construction. For the name of your nearest authorized Viking Range, LLC service agency, call Viking Range, LLC.

IMPORTANT: Retain proof of original purchase to establish warranty period.

Specifications subject to change without notice.