

Product and Cut-out Dimensions Built-in Ventilation System

DA2280

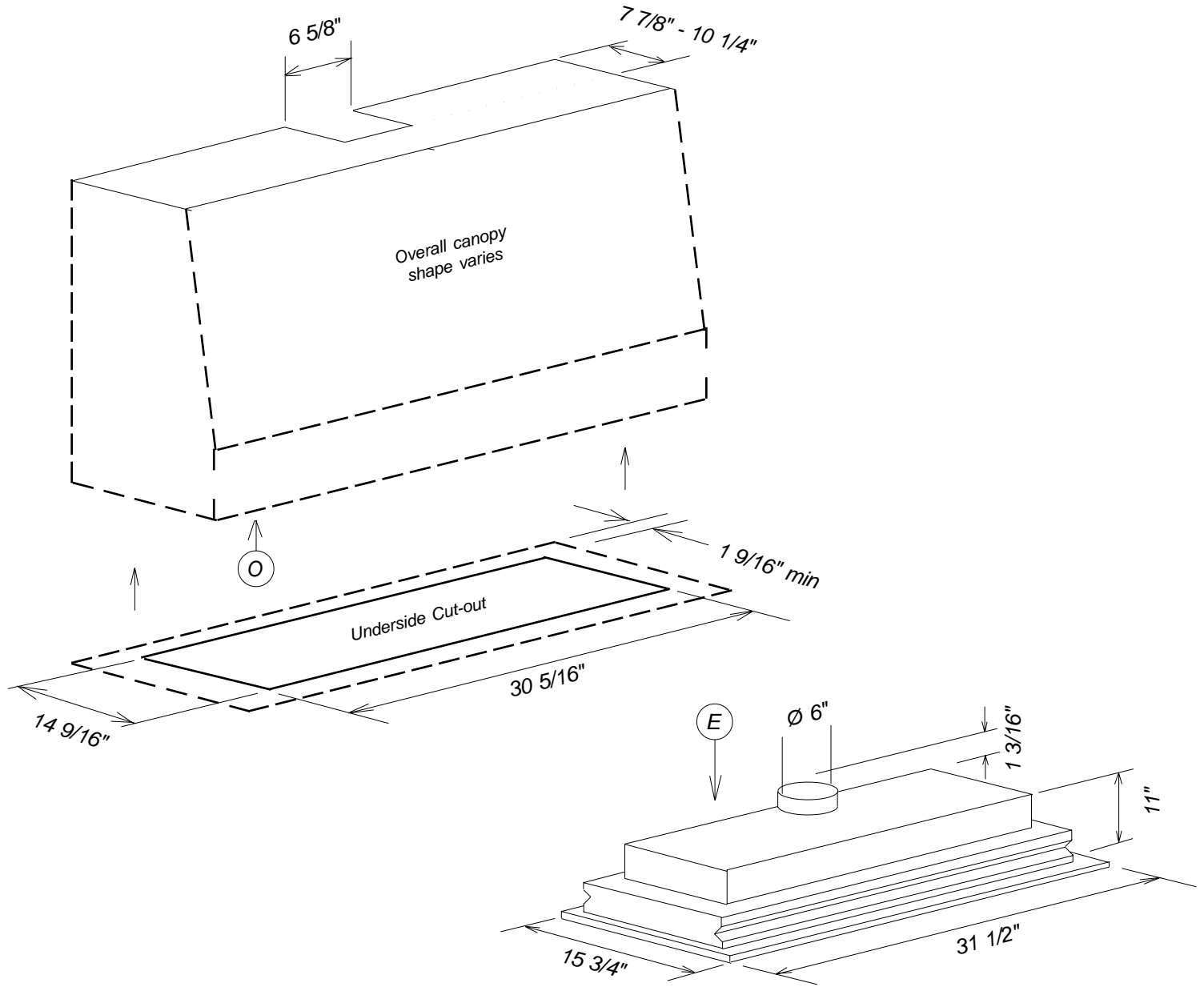

Location Codes	
E -	5 foot - 120 Volt - 15 Amp 3-wire molded plug power supply connects right rear top.
O -	Standard 110 Volt outlet
Notes	
<ul style="list-style-type: none"> • All installations must be done in accordance with local codes. • Center unit over cooking surface • Distance "S" is determined by the cooking surface. Minimum distance "S" is: <ul style="list-style-type: none"> - 24" for electric surfaces - 24" for gas surfaces based on BTU output (see hood instructions for details) 	

NOTE: Drawing is not to scale.
SPECIFICATION SHEETS 011208