

Date: _____ For: File Resubmit
 PO No.: _____ Approval Other _____
 Architect: _____ GC: _____
 Engr: _____ Mech: _____
 Rep: _____
 (Company) _____ (Project Manager) _____



LMAN097HVP
 Multi F Art Cool™ Gallery
 9,000 Btu/h Indoor Unit



Performance:

Nominal Cooling Capacity (Btu/h)	9,000
Nominal Heating Capacity (Btu/h)	10,400

Cooling Nominal Test Conditions: Indoor: 80°F DB/67°F WB Outdoor: 95°F DB/75°F WB
 Heating Nominal Test Conditions: Indoor: 70°F DB/60°F WB Outdoor: 47°F DB/43°F WB

Electrical:

Power Supply (V ¹ /Hz/Ø)	208-230/60/1
Rated Amps (A)	0.2

Piping:

Liquid Line (in, OD)	1/4
Vapor Line (in, OD)	3/8
Drain OD, ID (in)	13/16, 5/8
Temperature Sensor	Thermistor

Features:

- 24-Hour on/off timer
- Auto operation
- Auto restart
- Chaos Swing
- Inverter (variable speed fan)
- Jet Cool/Jet Heat
- Self-cleaning indoor coil
- Condensate sensor connection
- Group control

Included Accessories:

- Wireless Handheld Remote Controller - AKB73635607

Optional Accessories:

- LG Programmable Thermostat - PREMTB10U
- Simple Controller with Mode (Black) - PQRVCVCL0Q
- Simple Controller with Mode (White) - PQRVCVCL0QW
- Simple Controller without Mode (Black) - PQRCHCA0Q
- Simple Controller without Mode (White) - PQRCHCA0QW
- AC Smart Premium - PQCSW421E0A
- ACP Premium - PQPC22A1
- ACP Standard - PQPC22N1
- LonWorks Gateway - PQNFB16A1
- BACnet Gateway - PQNFB17B0
- AC Ez - PQCSZ250S0
- Dry Contact Unit (1 contact, 24 VAC external power) - PQDSB1
- Dry Contact Unit (2 input, power from indoor unit) - PQDSBC
- Dry Contact for third party thermostat - PQDSBNGCM1

Operating Range:

Cooling (°F WB)	57-77
Heating (°F DB)	59-81

Unit Data:

Refrigerant Type	R410A
Refrigerant Control	EEV
Sound Pressure ² H/M/L (±3 dB(A))	39/35/31
Primary Filter	Washable Pre-filter
Net Unit Weight (lbs)	32
Shipping Weight (lbs)	37

Fan:

Type	Turbo
Quantity	1
Motor/Drive	Brushless Digitally Controlled/Direct
Airflow Rate H/M/L (CFM)	272/208/155

Notes:

1. Acceptable operating voltage: 187V - 253V.
2. Sound Pressure levels are tested in an anechoic chamber under ISO Standard 1996.
3. See Engineering Manual for sensible and latent capacities.
4. All power/communication cable to be minimum 18 AWG, 4-conductor, stranded, shielded and must comply with applicable local and national code.
5. Power wiring cable size must comply with the applicable local and national code.
6. This unit comes with a dry helium charge.
7. Corresponding refrigerant piping length is in accordance with standard length of each outdoor unit and the level difference is 0 ft. All capacities are net with a combination ratio between 95 - 105%
8. Must follow installation instructions in the applicable LG installation manual.



LMAN097HVP
 Multi F Art Cool™ Gallery
 9,000 Btu/h Indoor Unit



Tag #: _____
 Date: _____
 PO No.: _____

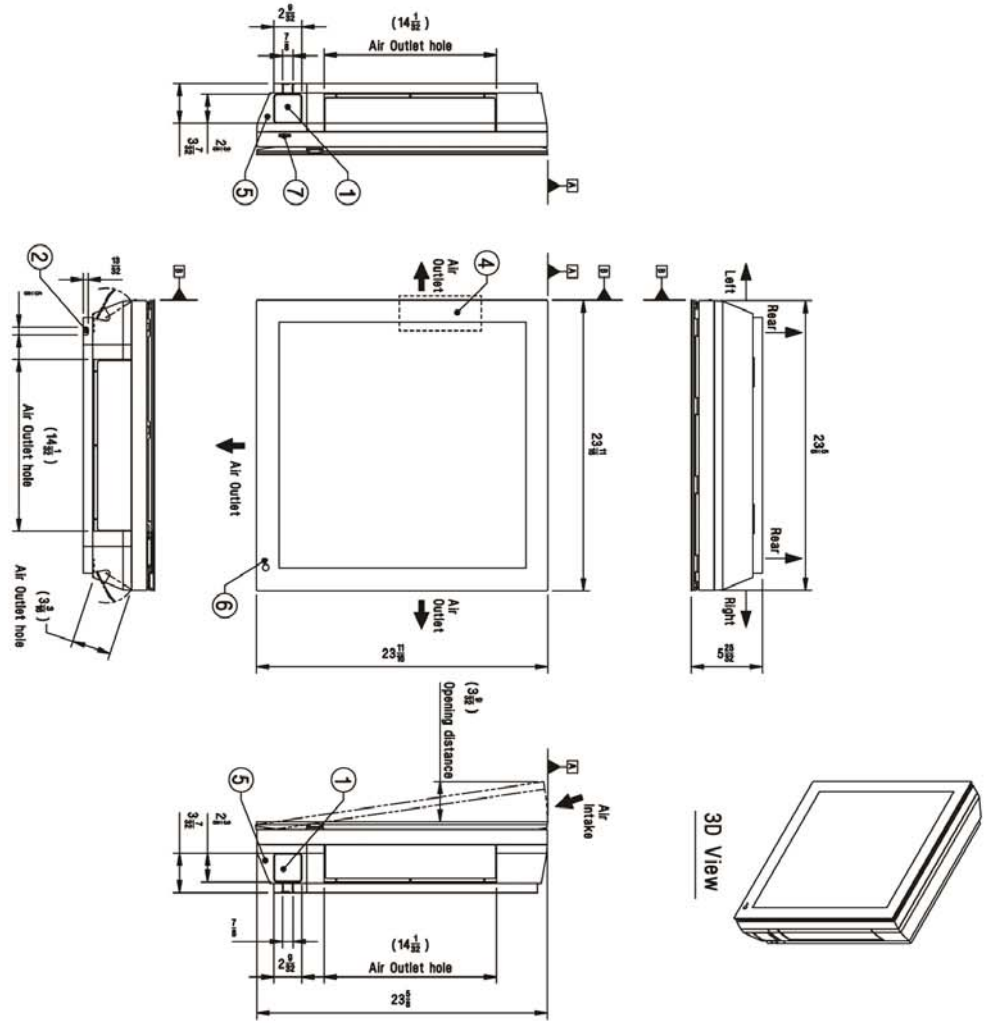

No.	Part Name	Description
1	Refrigerant/drain pipe and cable routing hole	Knock-out type
2	Cable routing hole	-
3	Drain hose connection	-
4	Terminal block for power supply and communication	Inside of front panel
5	Corner cover	-
6	Remote controller signal receiver	For wireless Type
7	Forced ON/OFF button	-