

60"

CULINARIAN SERIES



RANGE-TOP



CGRT604GB2



Power Burner



12" or 24" Griddle
12" or 24" BBQ Grill



Cast Iron Wok Grate
Accessory

60" RANGE-TOP FEATURES

- * ALL BURNERS ARE RATED AT 23,000 Btu / hr to deliver intense commercial kitchen heat to sauté food and all burners are capable of turning down to give 145° F simmer.
- * Commercial Quality Broiler Grates With Cast Iron Grease Gutters.
- * Quality Cast Iron Grates and Burners Porcelain Coated
- * HYBRID RADIANTS With Ceramic Rods Encased in Stainless Steel Sheet Metal.
- * 18,000 BTU Thermo-Griddle-Plate™- 3/8" thick 12" Width Stainless steel thermostatically controlled .
- * 30,000 BTU Thermo-Griddle-Plate™- 3/8" thick 24" Width Stainless steel thermostatically controlled .
- * EZ-Glides™ - Full extension removable drip trays mounted on ball bearing rails.
- * Stay-Cool™ - Die cast, chrome plated metal knobs with Black Trims (cabernet red optional)
Auto-ignition/re-ignition on all burners.
- * Stainless steel BBQ grill and griddle covers come standard.

AVAILABLE ACCESSORIES

- Conversion kits.
- Birch wood chopping blocks.
- Cabernet Red knobs.
- P60SHS - 18" stainless steel wall mount high shelf .
- P60SLB - 9" stainless steel wall mount low back .
- CWR Cast Iron Wok ring.
- PSVH60L - 60" Performance Series vent hood w/ 1200 CFM blower + lights .
- PSVH60HL - 60" Performance Series vent hood w/ 1200 CFM blower + heat lamps + lights.
- Duct covers.

SHIPPING WEIGHT

270 LBS

ELECTRICAL RATINGS

VOLTAGE	CURRENT/POWER	FREQUENCY
120 VAC	15 AMP	60 HZ

GAS RATINGS

Manifold pressure:	NATURAL GAS	PROPANE
	5.0" W.C.	10" W.C.

* Capital Exclusive Features



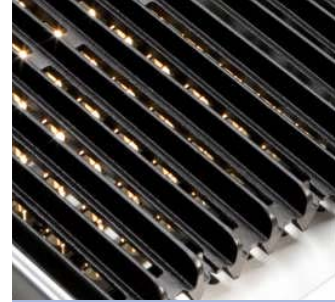

Power-Flo Open Top Burner
23,000 btus/hr

Simmer
turning down to give 145° F

Optional Cabernet
red knobs

HYBRID RADIANTS
Ceramic Rods & Stainless Steel

Broiler Grates
Commercial Quality Cast Iron

WARRANTY

OTHER

ONE (1) Year full parts and labor covers entire product. (Light bulbs covered for 60 days after installation)

0" clearance base cabinet installation
Field convertible to LP or NG depending on gas type

FIVE (5) Years limited part replacement warranty. Covers part replacement, as noted below, due to malfunction during normal operation.

Ranges*, Range Tops*, & Ovens*: All Burners, Heating Elements, Grates*, Griddle Plates, & Oven Racks
Barbeques: Gas Valves & all burners (excluding infrared burners)
*Excludes Porcelain Enamel Coating for ovens and grates. Porcelain enamel is prone to wear over time and use.

LIFETIME warranty (non-transferable) on stainless steel sheet metal body parts against rust. (Excludes damage and normal heat discoloration). Does not include barbeque grates.

60" RANGE-TOP

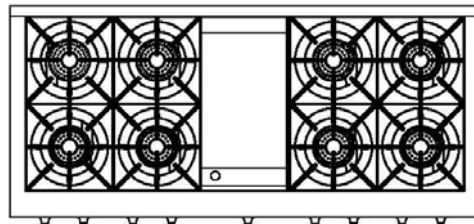

CGRT604G4 - 60"
Eight-burner gas 12" Griddle-Plate

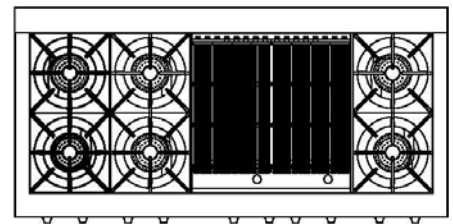

CGRT604BB2 - 60"
Six-burner gas + 24" BBQ Grill

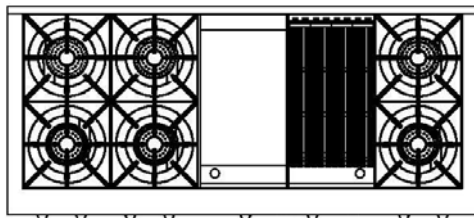

CGRT604GB2 - 60"
Six-burner gas 12" Griddle-Plate
+ BBQ Grill

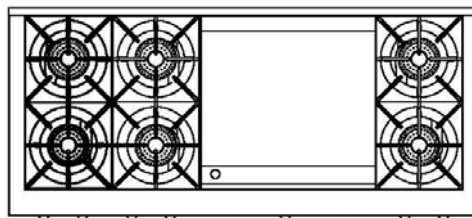

CGRT604GG2 - 60"
Six-burner gas + 24" Griddle-Plate

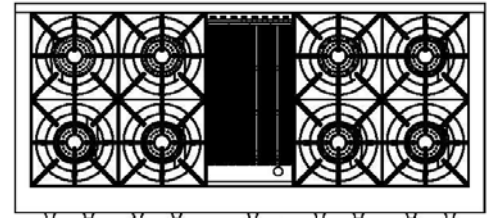

CGRT604B4 - 60"
Eight-burner gas + 12" BBQ Grill



CUT-OUT DIMENSIONS

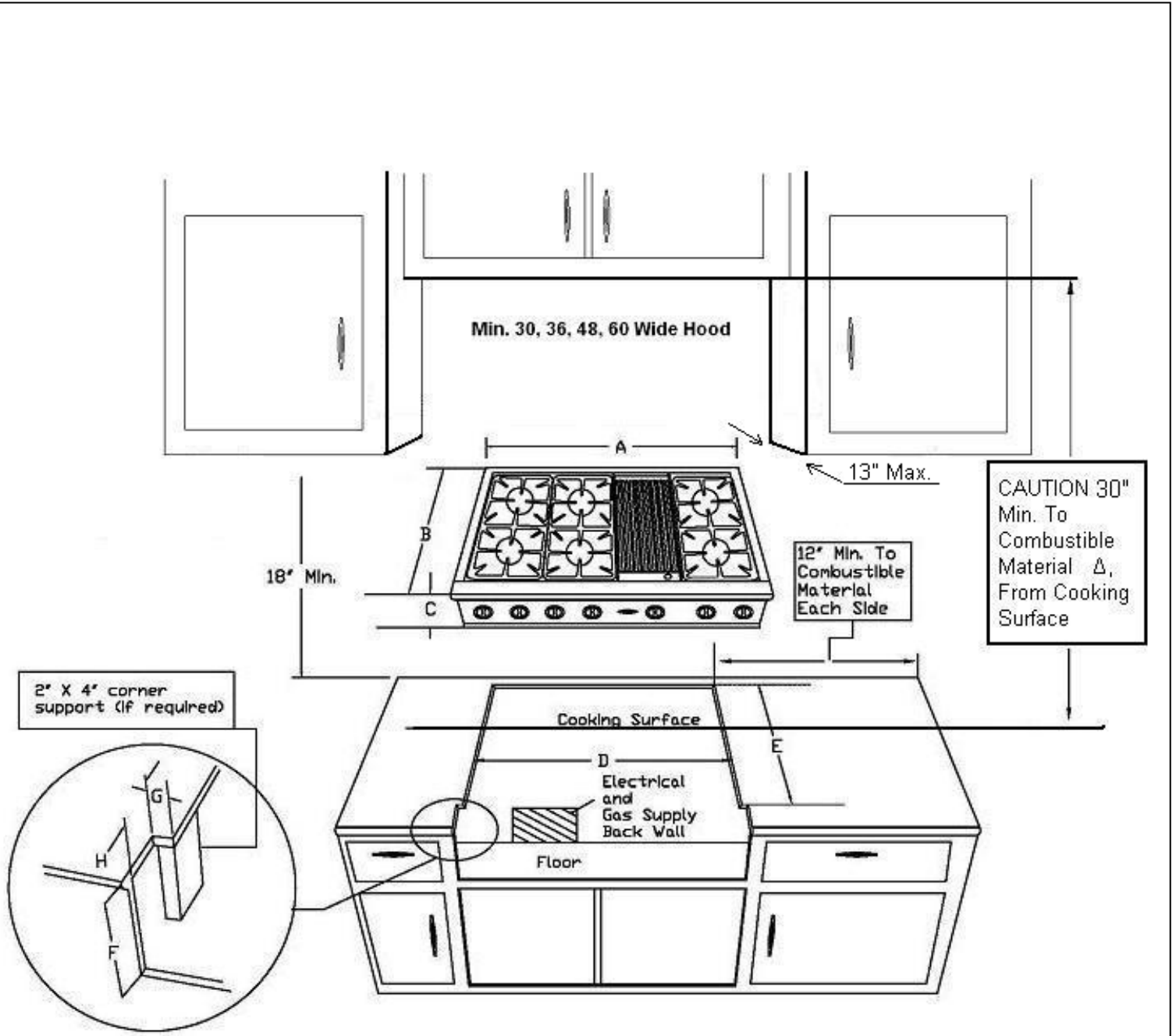

FIG 1

MODELS	A	B	C	D	E	F	G	H
CGRT30 Models	29-7/8	26-5/8	8-5/16	28-15/16	23-1/8	7-1/2	1/2	2-1/2
CGRT36 Models	35-7/8	26-5/8	8-5/16	34-15/16	23-1/8	7-1/2	1/2	2-1/2
CGRT48 Models	47-7/8	26-5/8	8-5/16	46-15/16	23-1/8	7-1/2	1/2	2-1/2
CGRT60 Models	59-7/8	26-5/8	8-5/16	58-15/16	23-1/8	7-1/2	1/2	2-1/2



RANGETOP & BACK GUARD DIMENSIONS

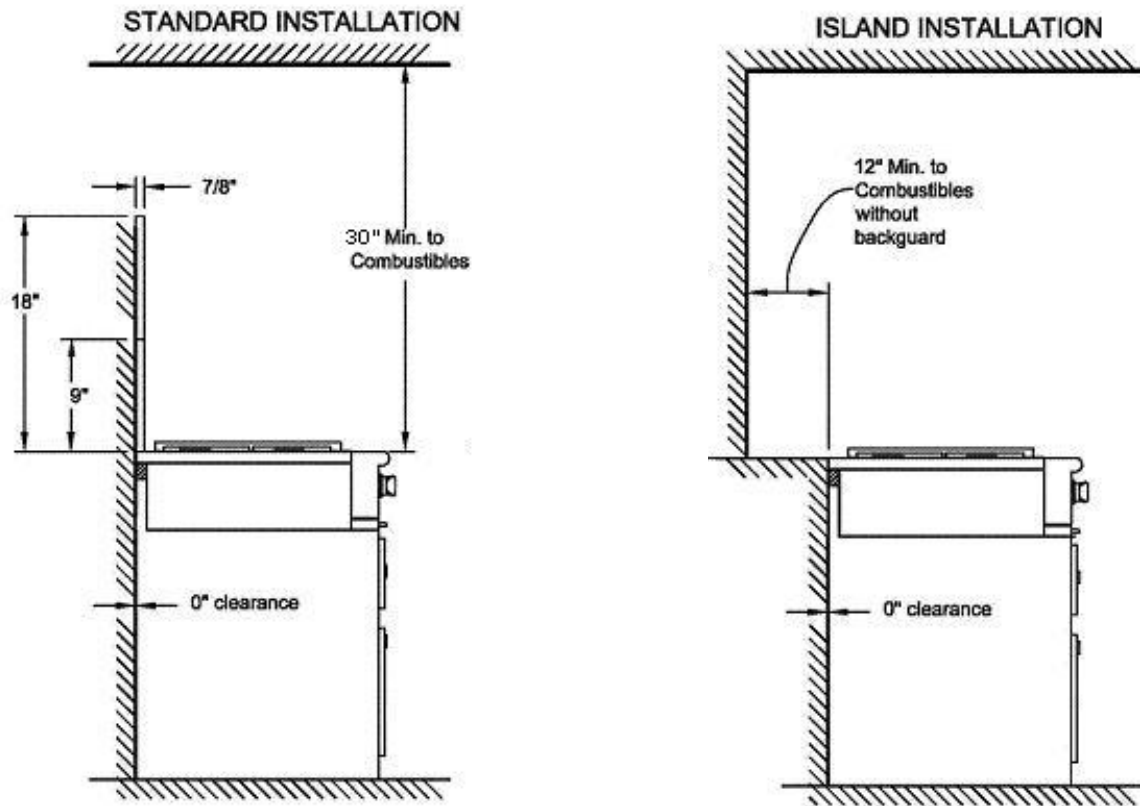
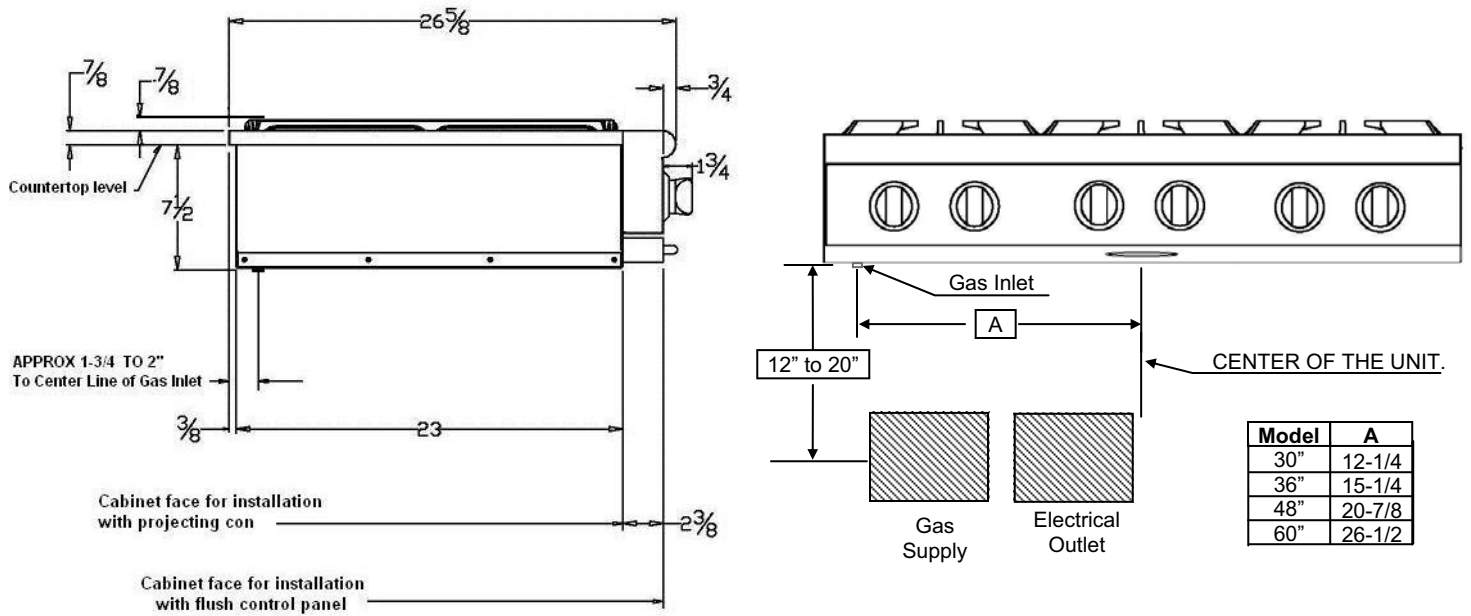

FIG 4
RANGE TOP



Model	A
30"	12-1/4
36"	15-1/4
48"	20-7/8
60"	26-1/2

