



36-INCH PRO DUAL-FUEL RANGE

HDPR36 | HERITAGE COLLECTION



AVAILABLE MODELS

HDPR36/NG	36" Heritage Dual Fuel Pro Range - Stainless Steel Natural Gas
HDPR36/LP/H	36" Heritage Dual Fuel Pro Range - Stainless Steel Liquid Propane High Alt.
HDPR36/LP	36" Heritage Dual Fuel Pro Range - Stainless Steel Liquid Propane
HDPR36/NG/H	36" Heritage Dual Fuel Pro Range - Natural Gas High Altitude
HDPR36C/NG/H	36" Heritage Dual Fuel Pro Range - Color Match Natural Gas High Altitude
HDPR36C/NG	36" Heritage Dual Fuel Pro Range - Color Match Natural Gas
HDPR36C/LP/H	36" Heritage Dual Fuel Pro Range - Color Match Liquid Propane High Altitude
HDPR36C/LP	36" Heritage Dual Fuel Pro Range - Color Match Liquid Propane

FEATURES & BENEFITS

- Exclusive Four-Part Pure Convection - heating element, air baffle, fan and filter to precisely distribute heat for superior cooking results.
- Large oven capacity - 5.2 cu. ft.
- 6 Dual-Stack Sealed Burners.
- Powerful 18K BTU and true simmer burners.
- Illumina™ Knobs - White LED
- LED Tilt-View™ Glass Touch Control
- Soft Close Oven Door
- Continuous Grate Platform
- All Brass Valves, Heads and Caps

ADDITIONAL FEATURES

CLEANING TYPE	SELF CLEAN GREENCLEAN™
TYPE OF GRATE	CONTINUOUS CAST IRON
CAVITY	BLACK ENAMEL COATING
RACK POSITIONS	6
LIGHTING	LED & HALOGEN

GENERAL PROPERTIES

OVEN CAPACITY (CUBIC FEET)	5.2 CU FT.
COOKING MODES	PURE CONVECTION™ CONVECTION BAKE CONVECTION BROIL CONVECTION ROAST BAKE BROIL

OVEN PERFORMANCE

BAKE ELEMENT	3,000W - 8 PASS
BROIL ELEMENT	3,500W - 8 PASS
CONVECTION ELEMENT	2,600W - 2 PASS

BURNER PERFORMANCE

TOTAL NUMBER OF COOKTOP BURNERS	6 DUAL STACK BRASS BURNERS
LEFT FRONT (BTU)	18,000 DUAL (SIMMER/SEAR)
LEFT REAR (BTU)	15,000 STACK DUAL (SIMMER)
CENTER FRONT (BTU)	15,000 STACK DUAL (SIMMER)
CENTER REAR (BTU)	15,000 STACK DUAL (SIMMER)
RIGHT FRONT (BTU)	18,000 STACK DUAL (SIMMER/SEAR)
RIGHT REAR (BTU)	15,000 STACK DUAL (SIMMER)
SEALED BURNERS	YES
PERMA-FLAME™ (AUTO RE-IGNITION)	YES

ADDITIONAL MODES

KEEP WARM	YES
PROOF	YES
TEMPERATURE PROBE	YES
DEHYDRATE	YES
SABBATH	YES

CONTROL FEATURES

LED (WHITE)	YES
NUMBER OF KNOBS	6 KNOBS
CONTROL METHOD	LED GLASS TOUCH CONTROL
ILLUMINA™ BURNER KNOBS	YES
HIGHLIGHTING COLOR	WHITE
CLOCK	YES
DELAY START	YES
KITCHEN TIMER	YES 2
TIME OF DAY (12 HR/24 HR)	YES
TEMPERATURE (F/C)	YES
CHILD LOCK	YES
SOUND ON/OFF	YES

TECHNICAL DETAILS

CIRCUIT BREAKER (A)	50 AMP
VOLTS (V)	240 V
FREQUENCY (HZ)	60 HZ
ENERGY SOURCE	GAS AND ELECTRICAL
GAS TYPES	NATURAL GAS NATURAL GAS (HIGH ALTITUDE) LIQUID PROPANE LIQUID PROPANE (HIGH ALTITUDE)

DIMENSIONS & WEIGHT

APPLIANCE DIMENSIONS (H X W X D) (IN.)	36 1/8" X 35 7/8" X 26 7/8"
REQUIRED CUTOUT SIZE (W X D) (IN.)	36" X 24"

dacor

36-INCH PRO DUAL-FUEL RANGE

APPLIANCE DIMENSIONS

48"

A (WIDTH)	35 7/8" (121.6CM)
B (DEPTH)	24" (60.1CM)
C (HEIGHT)	36 3/16" TO 37 1/2" (91.9-95.3CM)

Product tolerances: +/- 1/6" (+/-1.6MM)

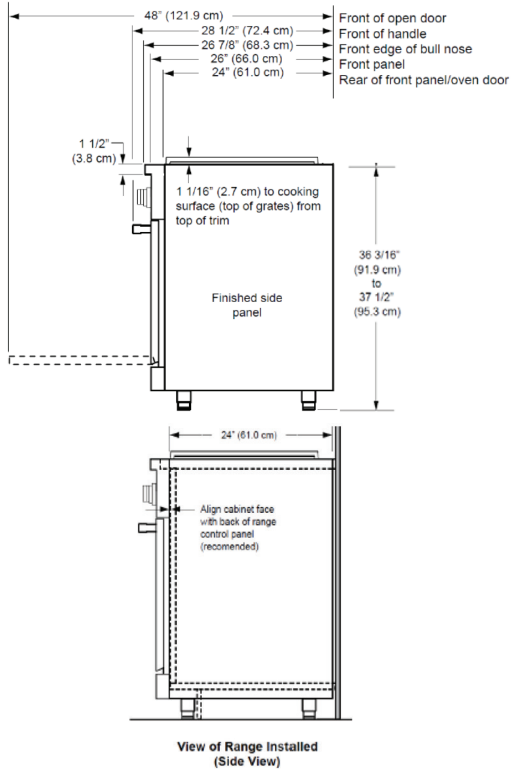

CABINET CUT-OUT DIMENSIONS

RANGE MODEL	F	G
HDPR36	42" (106.7 CM)* 36" (91.4 CM)**	36" (91.4 CM)**

* Recommended
** Minimum

Cutout tolerances: +1/16" (+1.6 mm), -0 unless otherwise stated

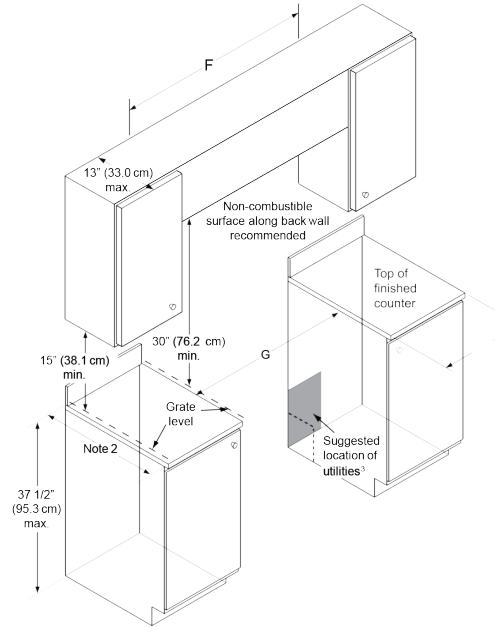

ACCESSORIES (INCLUDED)

GLIDERACK™	2 (LG) & 2 (SM)
STANDARD RACK	1 (LG) / 1 (SM)
TEMPERATURE PROBE	1 LG OVEN
WOK RING	1
CONVECTION FILTER	1/EA OVEN
BRASS/BLACK PORCELAIN BURNER CAPS	6/EA
REMOVABLE NON-STICK GRIDDLE	1

ACCESSORIES (OPTIONAL)

COOKIE SHEETS (SET OF 3)	ACSRO303
REMOVABLE NON-STICK GRIDDLE	AG30
REMOVABLE NON-STICK SEARING GRILL	AEGR30
BAKING STONE	ABS16
BROIL/ROASTING PAN W/GRILL & V RACK	AORPVR
STAINLESS STEEL BACKGUARD, MOUNTS TO UNIT (3 IN HIGH)	AERB48D3
STAINLESS STEEL BACKGUARD, MOUNTS TO UNIT (9 IN HIGH)	AERB30D9
3" SIDE PANELS	ARSP3

WARRANTY

LIMITED, PARTS AND LABOR	1 YEAR
--------------------------	--------