

Date: _____

For: File Resubmit

PO No.: _____

 Approval Other _____

Architect: _____

GC: _____

Engr: _____

Mech: _____

Rep: _____

(Company)

(Project Manager)

PMBD3620**2-Port Branch Distribution Unit (BD Unit)****Performance:**

Max Nominal Port Capacity Btu/h (each port)	24,000
Max Nominal Unit Capacity Btu/h (sum of ports)	48,000
Power Input (W)	16

Electrical:

Power Supply (V ¹ /Hz/∅)	208-230/60/1
Rated Amps (A)	0.08

Piping:**Piping Connection to Outdoor Unit:**

Liquid Line (in, OD)	3/8
Vapor Line (in, OD)	3/4

Piping Connection to Indoor Unit:

Liquid Line (in, OD)	1/4 (Qty 2)
Vapor Line (in, OD)	3/8 (Qty 2)

Standard Features:

- Distributes refrigerant to indoor units
- Internal components are insulated
- Flare joints provided for easy installation
- Compact design

Operating Range:

Operating Range (°F DB)	0-150
-------------------------	-------

Unit Data:

Net Weight (lbs)	13
Shipping Weight (lbs)	15

Notes:

1. Acceptable operating voltage: 187V-253V.
2. All power/communication cable to be minimum 16 AWG from the outdoor unit to the BD unit and 18 AWG from the BD unit to the indoor unit.
3. All power/communication cable to be 4-conductor, stranded, shielded and must comply with applicable local and national code.
4. Piping lengths:
 - Maximum height difference between BD unit and indoor units - 32.8 ft
 - Maximum height difference between BD unit and BD unit - 49.2 ft.
 - Maximum piping length between BD unit and indoor units - 49.2 ft
5. The BD unit should be installed inside of a building.
6. Must follow installation instructions in the applicable LG installation manual.
7. Power wiring cable size must comply with the applicable local and national code.

PMBD3620

2-Port Branch Distribution Unit (BD Unit)



Tag #:

Date:

PO No.:

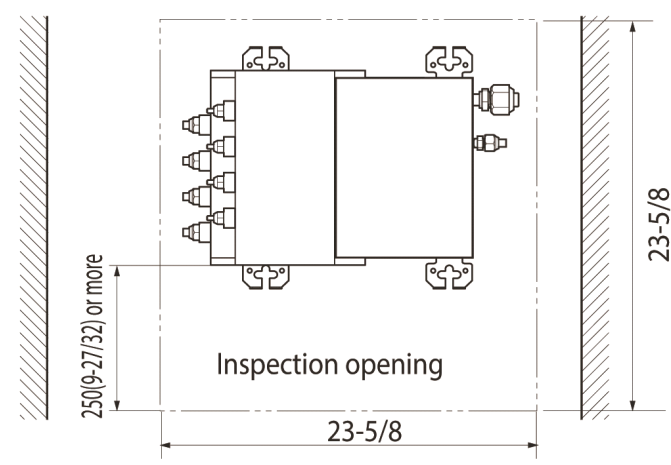
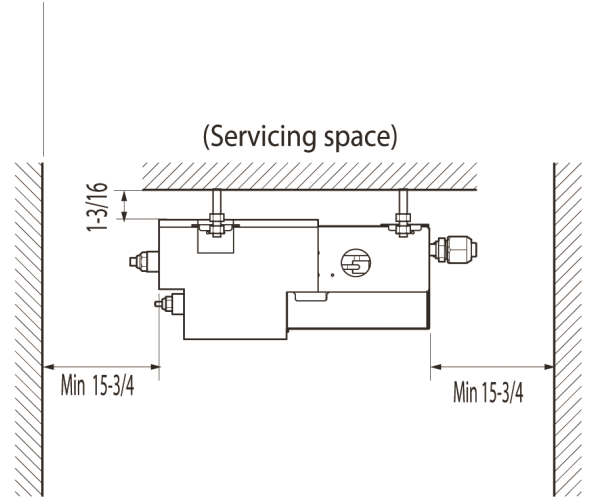
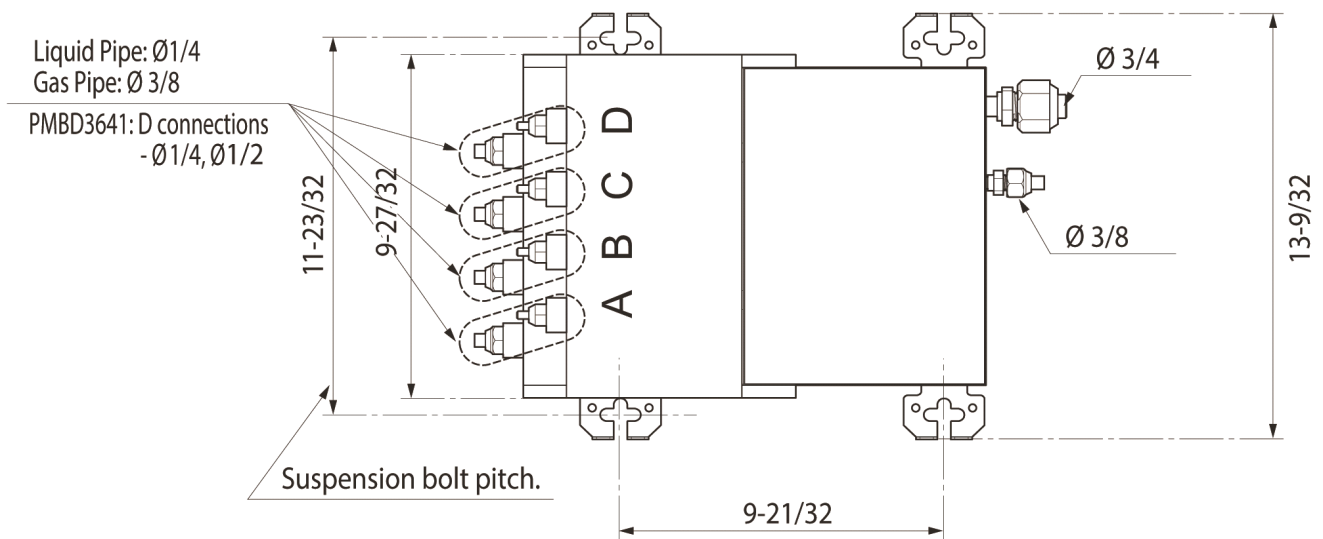
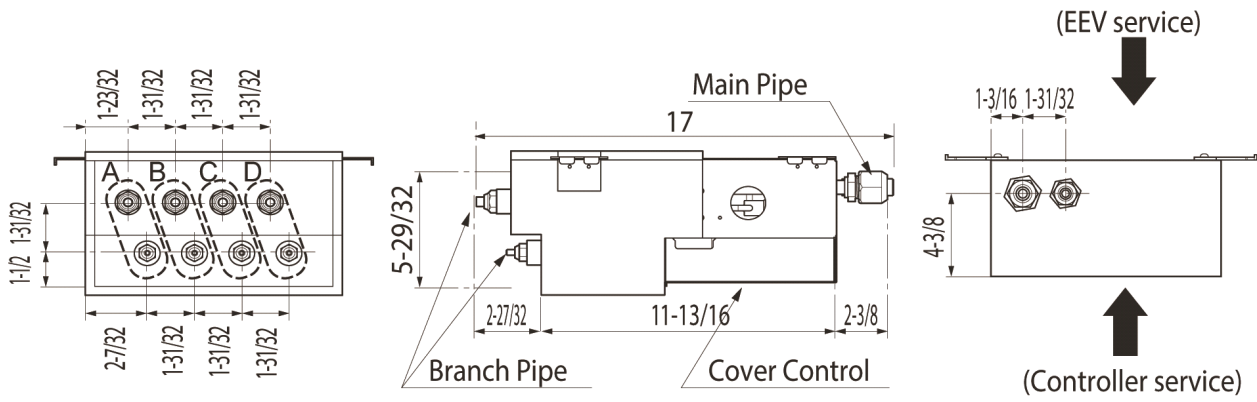

Notes

1. For PMBD3620 unit, ports A and B are available.
2. For PMBD3630 unit, ports A, B and C are available.
3. For PMBD3640 and PMBD3641 units, ports A, B, C and D are available.

Unit : inch