

FRIGIDAIRE GALLERY

FGBM19WNVF
FGBM19WNV

Available Colors : Stainless Steel, Black Stainless Steel

Version : 10/19

Over-The-Range Microwave

1.9 Cu. Ft. Over-The-Range Microwave



Product Specifications

Sensor Features

Sensor Cooking Options	Yes
------------------------	-----

Exterior Dimensions

Depth	15-3/4"
Height	16-3/8"
Width	29-7/8"

Cut-Out Dimensions

Cut-Out Depth (Max.)	14"
Cut-Out Depth (Min)	13"
Cut-Out Height (Max)	17"
Cut-Out Height (Min)	16-3/4"
Cut-Out Width	30"

Microwave Oven Specifications

Frequency (Mhz)	2450
Interior Light Wattage	1.2
Microwave Turntable Diameter	13-5/8"
Watts	1000

General Specifications

Interior Light	LED
PROP 65 Label	Yes
Turntable Material	Glass

Internal Specifications

Oven Interior	White
Microwave Interior Depth	14-9/16"
Microwave Interior Height	10-9/16"
Interior Light	Yes
Microwave Interior Width	21-3/32"

Vent & Light System

Auto-start Heat Sensor	Yes
Charcoal Filter	Yes - 1
Cooktop Light	High Night Off
Ducted / Ductless Vent Installation	Yes
Exhaust Fan Speeds	2 speeds - Off 105 300 CFM
Grease Filter (Dishwasher Safe)	Yes - 2
Heat Deflector	No
Lights	2
Vent Style	Hidden

Certifications & Approvals

ADA Compliant	No
CDRH Approval	Yes
ETL Listed	No
NSF® Certified	No
UL/cUL Approval	Yes

Controls

Add 30 Seconds	Yes
Clock	Yes
Controls	Glass Touch
Display Color	White
Display Type	LED
Electronic Clock	Yes
Numeric Touch Pad	Yes
Power Levels	High / 1-9
Quick Settings (Time)	No
Start Button	Yes
Stop / Cancel Button	Yes
Timer Function	Yes 99:99
Touch Pad Buttons	28
Turntable On / Off	Yes - Under Settings

Microwave Oven Controls

Auto Defrost (Keep Warm)	No
Baked Potato	Yes - 1 - 4
Chicken Nuggets	No
Defrost Options	Yes - Weight & Time
Keep Warm	No
Melt/Soften	Yes - Melt Butter Melt Chocolate Soften Ice Cream Soften Cream Cheese
Multi-Stage Cooking Option(s)	No
Popcorn	Yes - Options for 1.75/3.0/3.3 oz.
Quick Start	No
Reheat Option(s)	Yes - Soup/Sauce Pizza Dinner Plate Casserole/Pasta Roll/Muffin
Sensor Cook Options	Yes - Bacon Frozen Dinner White Rice Frozen Breakfast
Snack Option(s)	No
Start Button	Yes
Stop Button	Yes

User Modes

Child Lock	Yes - with Stop/Cancel Key
Clock	Yes
Demo Mode	Yes
Language (En/Fr/Sp)	Yes
Audible Signal On/Off / Adjustable	On / Off
User Selectable Weight (lb/kg)	Yes
User Preferences	Yes

Electrical Specifications

Amps @ 120 Volts	13.5
Connected Load (kW Rating) @ 120V	1.55
Power Supply Connection Location	Right Rear Top
Voltage Rating	120V 60Hz

Capacities

Capacity (Cu. Ft.)	1.9
--------------------	-----

FRIGIDAIRE GALLERY.

FGBM19WNVF
FGBM19WNVD

Available Colors : Stainless Steel, Black Stainless Steel

Version : 10/19

Over-The-Range Microwave

1.9 Cu. Ft. Over-The-Range Microwave

Installation Drawing

Locate 120V/60Hz grounded outlet inside upper cabinet

Microwave MUST be mounted to BOTH a top cabinet† AND a wall.*

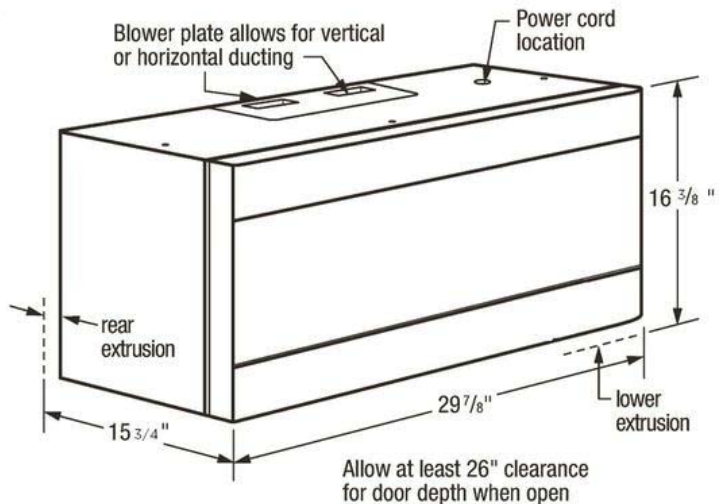
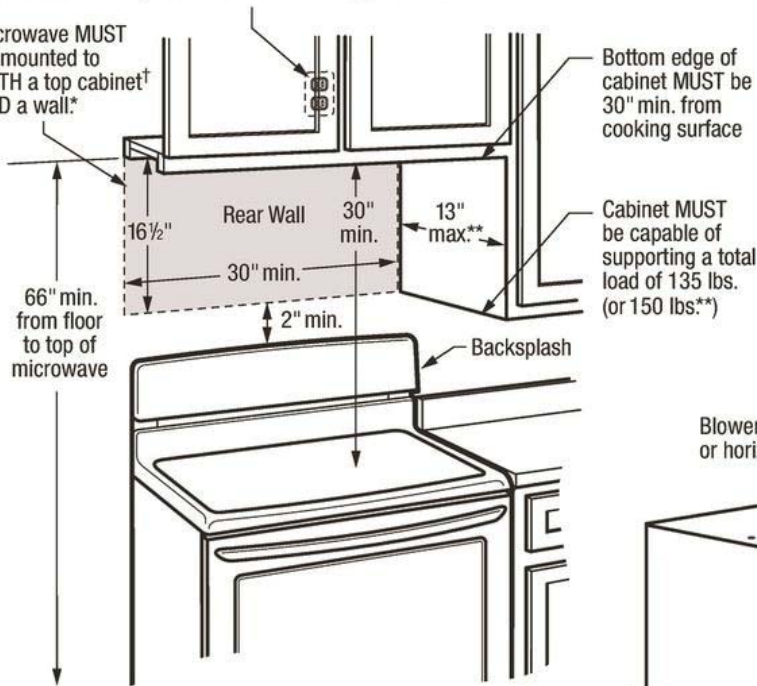

†When installing beneath smooth, flat cabinets, refer to cabinet template for detailed power cord clearance instructions

*Can NOT be installed in island or peninsula cabinet arrangements

**If cabinet depth (including doors) is deeper than 13", unit MUST be spaced out from rear wall using adequate materials (supporting 150 lbs.) to allow proper top vent air exhaust/intake

Note: For planning purposes only. Always consult local and national electric, gas and plumbing codes. Refer to Product Installation Guide for detailed installation instructions on the web at frigidaire.com/frigidaire.ca. Specifications subject to change. Accessories information available on the web at frigidaire.com/frigidaire.ca