



UNDERCOUNTER REFRIGERATOR

15"W. VURE515GSS and 24"W. VURE524GSS

FEATURES

- Storage Capacity
 - 15"W. model:
Volume of 2.9 cu. ft. holds up to 47 bottles (12 oz.) or 72 cans (12 oz.)
 - 24"W. model:
Volume of 5.2 cu. ft. holds up to 94 bottles (12 oz.) or 148 cans (12 oz.)
- Full-depth lower interior maximizes storage options
- Variable speed compressor delivers maximum energy efficiency, faster temperature response, and quieter operation
- Convection cooling system provides a quick cool down and consistent temperature
- Temperature range: 33°F – 70°F
- Stainless steel interior
- Stainless steel cabinet, toe kick, and accents
- Easy adjusting interior with 19 adjustable positions
- Three removable, full-extension easy to load bins
- Digital touch pad control with blue LED display
- Adjustable bright white or blue LED lighting
- Soft close door with articulating hinge
- Field reversible door is shipped right-hand hinged
- Built-in or freestanding
- Four adjustable leveling legs'



MODEL NUMBERS

- VURE515GSS – 15"W. Undercounter Refrigerator
- VURE524GSS – 24"W. Undercounter Refrigerator

DESIGN OPTIONS

- Product ships as right hinge; field reversible

COLOR FINISHES

- Available in Stainless Steel (SS)

WARRANTY

- 2-year full covers complete unit
- 6-year full – sealed refrigeration system
- 90-day full – cosmetic parts such as glass, painted items, and decorative items
- 12-year limited – sealed refrigeration system

UNDERCOUNTER REFRIGERATOR

MODEL	VURE515GSS	VURE524GSS
Amps: Running	1.2	
Capacity: Bottle (12 oz)	47	94
Capacity: Can (12 oz)	72	148
Capacity Volume (cu ft)	2.9	5.2
Capacity: Wine Bottle (750 ml)	N/A	N/A
Dimensions: Product Depth	22 15/16" (583 mm)	
Dimensions: Product Height (Min.)	33 11/16" (855 mm)	
Dimensions: Product Width	14 15/16" (379 mm)	23 5/8" (600 mm)
Energy Consumption: Avg. Per Year	85 kWh	305 kWh
ENERGY STAR (glass door)	No	
Refrigerant Type:	R600a	
Sabbath (Star K Certified)	Yes	
Temperature Range	33°F – 70°F	
Voltage	115/60	
Weight	105 lb.	163 lb.

Please do not prepare installation from brochure data only.
See installation instructions for important clearance/installation information.



UNDERCOUNTER REFRIGERATOR

15"W. VURE515GSS and 24"W. VURE524GSS

FRONT

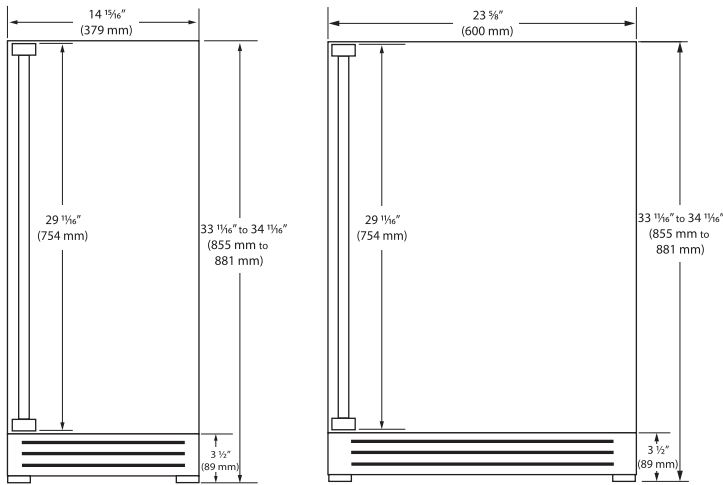

TOP

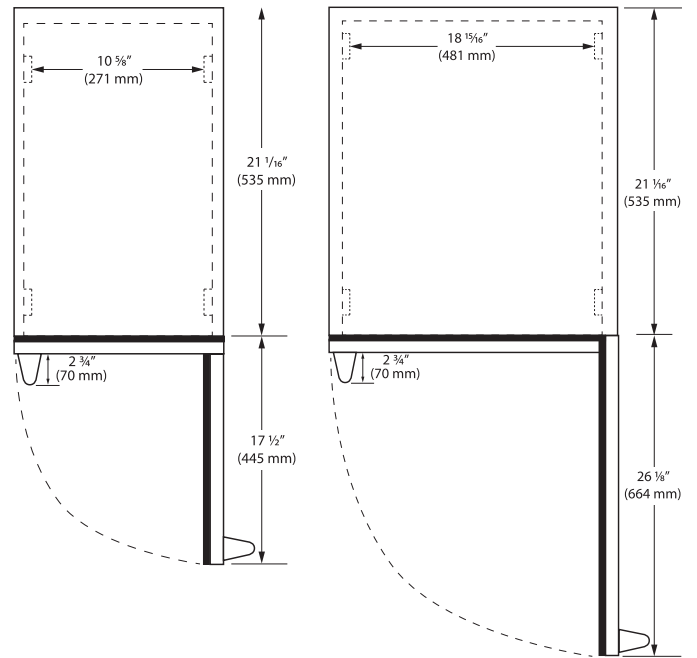

SIDE

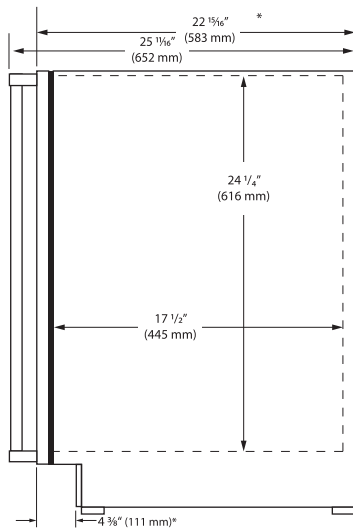

CUTOUT

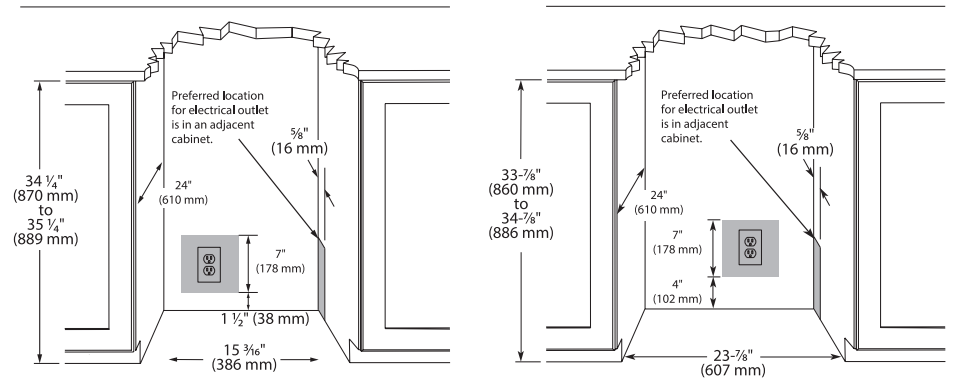

REAR

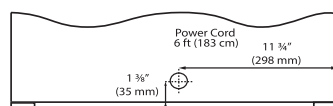
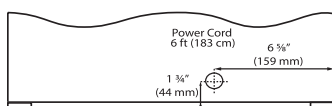

VIKING RANGE, LLC 111 FRONT STREET GREENWOOD, MISSISSIPPI 38930 USA

For detailed product information, model numbers, or to request a quote call 1-888-845-4641 or visit vikingrange.com
 © 2019 Viking Range, LLC All rights reserved. Specifications subject to change without notice.